

Appendix D

D-1 Alphabetical Conversion Factors

A

| | | |
|----------------------------|----------------------------|--------------------------------|
| Acre | × 10 | = Square chain (Gunters) |
| Acre | × 160 | = Rods |
| Acre | × 1 × 10 ⁵ | = Square links (Gunters) |
| Acre | × 0.4047 | = Hectare or square hectometer |
| Acres | × 43,560 | = Square feet |
| Acres | × 4,047 | = Square meters |
| Acres | × 1.562 × 10 ⁻³ | = Square miles |
| Acres | × 4,840 | = Square yards |
| Acre-feet | × 43,560 | = Cubic feet |
| Acre-feet | × 3.259 × 10 ⁵ | = Gallons |
| Amperes/square centimeters | × 6.452 | = Amperes/square inch |
| Amperes/square centimeters | × 10 ⁴ | = Amperes/square meter |
| Amperes/square inch | × 0.1550 | = Amperes/square centimeters |
| Amperes/square inches | × 1,550 | = Amperes/square meter |
| Amperes/square meter | × 10 ⁻⁴ | = Amperes/square centimeter |
| Amperes/square meter | × 6.452 × 10 ⁻⁴ | = Amperes/square inch |
| Ares | × 0.02471 | = Acre (USA) |
| Ares | × 119.60 | = Square yards |
| Ares | × 100 | = Square meters |
| Atmospheres | × 14.7 | = Pounds/square inch |
| Atmospheres | × 1.058 | = Tonnes/square foot |
| Atmospheres | × 29.92 | = Inches of mercury at 0° C |
| Atmospheres | × 76 | = Centimeters of mercury |
| Atmospheres | × 33.90 | = Feet of water at 4° C |
| Atmospheres | × 1.0333 | = Kilograms/square centimeter |
| Atmospheres | × 10,332 | = Kilograms/square meter |
| Atmospheres | × 1,013.2 | = Millibar |
| Atmospheres | × 760 | = Millimeters of mercury |
| Atmospheres | × 10.332 | = Meters of water at 4° C |

B

| | | |
|-------------------------|-----------------------------|---------------------------|
| Barrels (USA, dry) | × 7,056 | = Cubic inches |
| Barrels (USA, dry) | × 105 | = Quarts (dry) |
| Barrels (USA, liquid) | × 31.5 | = Gallons |
| Barrels (oil) | × 42 | = Gallons (oil) |
| Barrels (oil) | × 0.159 | = Cubic meters |
| Barrels (oil) | × 159 | = Liters |
| Barrels/day | × 6.6245 × 10 ⁻³ | = Cubic meters/hour |
| Barrels (oil) | × 5.6154 | = Cubic feet |
| Barrels/day | × 29.167 × 10 ⁻³ | = Gallons per minute |
| Bars | × 0.9869 | = Atmospheres |
| Bars | × 10 ⁶ | = Dynes/square centimeter |
| Bars | × 1.020 × 10 ⁴ | = Kilograms/square meter |
| Bars | × 2,089 | = Pounds/square foot |
| Bars | × 14.50 | = Pounds/square inch |
| Board feet × 144 sq.in. | × 1 in. | = Cubic inches |
| Board feet | × 0.0833 | = Cubic feet |
| Btu | × 1.055 × 10 ¹⁰ | = Ergs |
| Btu | × 778.3 | = Foot-pounds |
| Btu | × 252 | = Gram-calories |
| Btu | × 3.931 × 10 ⁻⁴ | = Horsepower-hours |
| Btu | × 1,054.8 | = Joules |
| Btu | × 0.252 | = Kilogram-calories |
| Btu | × 107.5 | = Kilogram-meters |
| Btu | × 2.928 × 10 ⁻⁴ | = Kilowatt-hours |
| Btu/hour | × 0.2162 | = Foot-pounds/second |
| Btu/hour | × 0.070 | = Gram-calorie/second |

864 APPENDIX D

| | | |
|---------------------------------------|-------------------------------|---------------------------------------|
| Btu/hour | $\times 3.929 \times 10^{-4}$ | = Horsepower-hours (British) |
| Btu/hour | $\times 0.2931$ | = Watts |
| Btu/hour foot ° F | $\times 1.4882$ | = Kilocalorie/meter hour ° C |
| Btu/hour foot ² | $\times 2.7125$ | = Kilocalorie/meter ² hour |
| Btu/pound | $\times 0.5556$ | = Kilocalorie/kilogram |
| Btu/pound ° F | $\times 1$ | = Kilocalorie/kilogram ° C |
| Btu inches/hour foot ² ° F | $\times 0.12402$ | = Kilocalorie/meter hour ° C |
| Btu/minute | $\times 12.96$ | = Foot-pounds/second |
| Btu/minute | $\times 0.02356$ | = Horsepower |
| Btu/minute | $\times 0.01757$ | = Kilowatts |
| Btu/minute | $\times 17.57$ | = Watts |
| Btu/square foot/minute | $\times 0.1221$ | = Watts/square inch |
| Bucket (British-dry) | $\times 1.818 \times 10^4$ | = Cubic centimeters |
| Bushels | $\times 1.2445$ | = Cubic feet |
| Bushels | $\times 2,150.4$ | = Cubic inches |
| Bushels | $\times 0.03524$ | = Cubic meters |
| Bushels | $\times 35.24$ | = Liters |
| Bushels | $\times 4$ | = Pecks |
| Bushels | $\times 64$ | = Pints (dry) |
| Bushels | $\times 32$ | = Quarts (dry) |

C

| | | |
|----------------------------|--------------------------------|------------------------------|
| Calories, gram (mean) | $\times 3.9685 \times 10^{-3}$ | = Btu (mean) |
| Calories/gram | $\times 1.8$ | = Btu/pound |
| Calories/gram-mol-° C | $\times 1.0$ | = Btu/pound-mol-° F |
| Candle/square centimeter | $\times 3.142$ | = Lamberts |
| Candle/square inch | $\times 0.487$ | = Lamberts |
| Centares | $\times 1.0$ | = Square meters |
| Centigrade | $\times 9/5 + 32$ | = Fahrenheit |
| Centiliter | $\times 0.3382$ | = Fluid ounce (USA) |
| Centiliter | $\times 0.6103$ | = Cubic inch |
| Centiliter | $\times 2.705$ | = Drams |
| Centimeters | $\times 3.281 \times 10^{-2}$ | = Feet |
| Centimeters | $\times 0.3937$ | = Inches |
| Centimeters | $\times 1.094 \times 10^{-2}$ | = Yards |
| Centimeters | $\times 393.7$ | = mils |
| Centimeters of mercury | $\times 0.1934$ | = Pounds/square inch |
| Centimeters of mercury | $\times 0.01316$ | = Atmospheres |
| Centimeters of mercury | $\times 0.4461$ | = Feet of water |
| Centimeters of mercury | $\times 136$ | = Kilograms/square meter |
| Centimeters of mercury | $\times 27.85$ | = Pounds/square foot |
| Centimeters of mercury | $\times 0.1934$ | = Pounds/square inch |
| Centimeters/second | $\times 1.1969$ | = Feet/minute |
| Centimeters/second | $\times 0.03281$ | = Feet/second |
| Centimeters/second | $\times 0.036$ | = Kilometers/hour |
| Centimeters/second | $\times 0.1943$ | = Knots |
| Centimeters/second | $\times 0.6$ | = Meters/minute |
| Centimeters/second | $\times 0.02237$ | = Miles/hour |
| Chain | $\times 792$ | = Inches |
| Chain | $\times 20.12$ | = Meters |
| Circumference | $\times 6.283$ | = Radians |
| Cords | $\times 8$ | = Cord feet |
| Cord feet | $\times 16$ | = Cubic feet |
| Coulomb | $\times 2.998 \times 10^9$ | = Statcoulombs |
| Coulombs | $\times 1.036 \times 10^{-5}$ | = Faradays |
| Coulombs/square centimeter | $\times 64.52$ | = Coulombs/square inch |
| Coulombs/square centimeter | $\times 10^4$ | = Coulombs/square meter |
| Coulombs/square inch | $\times 0.155$ | = Coulombs/square centimeter |
| Coulombs/square inch | $\times 1,550$ | = Coulombs/square meter |
| Cubic centimeters | $\times 3.531 \times 10^{-5}$ | = Cubic feet |
| Cubic centimeters | $\times 0.06102$ | = Cubic inches |
| Cubic centimeters | $\times 10^{-6}$ | = Cubic meters |
| Cubic centimeters | $\times 1.308 \times 10^{-6}$ | = Cubic yards |
| Cubic centimeters | $\times 2.624 \times 10^{-4}$ | = Gallons (USA liquid) |
| Cubic centimeters | $\times 0.001$ | = Liters |
| Cubic centimeters | $\times 2.113 \times 10^{-3}$ | = Pints (USA liquid) |
| Cubic centimeters | $\times 1.057 \times 10^{-3}$ | = Quarts (USA liquid) |
| Cubic feet | $\times 0.8036$ | = Bushels (dry) |
| Cubic feet | $\times 28,320$ | = Cubic centimeters |

APPENDIX D 865

| | | |
|------------------------|---------------------------|----------------------------|
| Cubic feet | ×1,728 | = Cubic inches |
| Cubic feet | ×0.02832 | = Cubic meters |
| Cubic feet | ×0.03704 | = Cubic yards |
| Cubic feet | ×7.48052 | = Gallons (USA liquid) |
| Cubic feet | ×6.232 | = Gallons (imperial) |
| Cubic feet | ×6.428 | = Gallons (USA dry) |
| Cubic feet | ×62.425 | = Pounds (water) |
| Cubic feet | ×28.32 | = Liters |
| Cubic feet | ×59.84 | = Pints (USA liquid) |
| Cubic feet | ×29.92 | = Quarts (USA liquid) |
| Cubic feet | ×0.1781 | = Barrels (oil, USA) |
| Cubic feet/minute | ×472 | = Cubic centimeters/second |
| Cubic feet/minute | ×0.1247 | = Gallons/second |
| Cubic feet/minute | ×0.4720 | = Liters/second |
| Cubic feet/minute | ×62.43 | = Pounds of water/minute |
| Cubic feet/minute | ×1.6989 | = Cubic meters/hour |
| Cubic feet/minute | ×4.719 × 10 ⁻⁴ | = Cubic meters/second |
| Cubic feet/second | ×0.646317 | = Million gallons/day |
| Cubic feet/second | ×448.831 | = Gallons/minute |
| Cubic feet/second | ×101.94 | = Cubic meters/hour |
| Cubic inches | ×16.39 | = Cubic centimeters |
| Cubic inches | ×5.787 × 10 ⁻⁴ | = Cubic feet |
| Cubic inches | ×1.639 × 10 ⁻⁵ | = Cubic meters |
| Cubic inches | ×2.143 × 10 ⁻⁵ | = cubic yards |
| Cubic inches | ×4.329 × 10 ⁻³ | = Gallons (U.S) |
| Cubic inches | ×0.01639 | = Liters |
| Cubic inches | ×1.061 × 10 ⁵ | = Mil-feet |
| Cubic inches | ×0.03463 | = Pints (USA liquid) |
| Cubic inches | ×0.01732 | = Quarts (USA liquid) |
| Cubic meters | ×6.290 | = Barrels(USA oil) |
| Cubic meters | ×28.38 | = Bushes(dry) |
| Cubic meters | ×10 ⁶ | = Cubic centimeters |
| Cubic meters | ×35.314 | = Cubic feet |
| Cubic meters | ×61,023 | = Cubic inches |
| Cubic meters | ×1.308 | = Cubic yards |
| Cubic meters | ×264.17 | = Gallons (USA liquid) |
| Cubic meters | ×220 | = Gallons (imperial) |
| Cubic meters | ×1,000 | = Liters |
| Cubic meters | ×2,113 | = Prints (USA liquid) |
| Cubic meters | ×1.057 | = Quarts (USA liquid) |
| Cubic meters/hour | ×9.810 × 10 ⁻³ | = Cubic feet/second |
| Cubic meters/hour | ×0.5886 | = Cubic feet/minute |
| Cubic meters/hour | ×4.4033 | = Gallons/minute (USA) |
| Cubic meters/hour | ×150.95 | = Barrels/day |
| Cubic meters/hour | ×3.6651 | = Imperial gallons/minute |
| Cubic meters/hour | ×35.31 | = Cubic feet/hour |
| Cubic meters/hour | ×277.8 | = Cubic centimeters/second |
| Cubic yards | ×7.646 × 10 ⁵ | = Cubic centimeters |
| Cubic yards | ×27 | = Cubic feet |
| Cubic yards | ×46,656 | = Cubic inches |
| Cubic yards | ×0.7646 | = Cubic meters |
| Cubic yards | ×202 | = Gallons (USA liquid) |
| Cubic yards | ×764.6 | = Liters |
| Cubic yards | ×1,615.9 | = Pints (USA liquid) |
| Cubic yards | ×807.9 | = Quarts (USA liquid) |
| Cubic yards/minute | ×0.45 | = Cubic feet/second |
| Cubic yards/minute | ×3.367 | = Gallons/second |
| Cubic yards/minute | ×12.74 | = Liters/second |
| Cubit (from The Bible) | ×21.8 | = Inch |
| Cup | ×0.5 | = Pint |
| Cup | ×16 | = Tablespoon |

D

| | | |
|------------|----------------------------|-----------|
| Dalton | ×1.650 × 10 ⁻²⁴ | = Gram |
| Days | ×1,440 | = Minutes |
| Days | ×86,400 | = Seconds |
| Decigrams | ×0.1 | = Grams |
| Deciliters | ×0.1 | = Liters |
| Decimeters | ×0.1 | = Meters |

866 APPENDIX D

| | | |
|------------------------------|-----------------------------|--------------------------------|
| Degrees (Angle) | ×60 | = Minutes |
| Degrees (Angle) | ×3600 | = Seconds |
| Degrees (Angle) | ×0.01745 | = Radians |
| Degrees (Angle) | ×0.01111 | = Quadrants |
| Degrees/second | ×0.1667 | = Revolutions/minute |
| Degrees/second | ×2.778 × 10 ⁻³ | = Revolutions/second |
| Dekagrams | ×10 | = Grams |
| Dekaliters | ×10 | = Liters |
| Dekameters | ×10 | = Meters |
| Drams (apothecaries or troy) | ×0.1371429 | = Ounces (avoirdupois) |
| Drams (apothecaries or troy) | ×0.125 | = Ounces (troy) |
| Drams | ×27.34375 | = Grains |
| Drams | ×1.771845 | = Grams |
| Drams | ×0.0625 | = Ounces |
| Dyne/centimeter | ×0.01 | = Erg/square millimeters |
| Dyne/square centimeters | ×9.869 × 10 ⁻⁷ | = Atmospheres |
| Dyne/square centimeters | ×2.953 × 10 ⁻⁵ | = Inch of mercury at 0° C |
| Dyne/square centimeters | ×4.015 × 10 ⁻⁴ | = Inch of water at 4° C |
| Dynes/square centimeters | ×10 ⁻⁶ | = Bars |
| Dynes | ×1.020 × 10 ⁻³ | = Grams |
| Dynes | ×10 ⁻⁷ | = Joules/centimeters |
| Dynes | ×10 ⁻⁵ | = Joules/meters (newtons) |
| Dynes | ×1.020 × 10 ⁻⁶ | = Kilograms |
| Dynes | ×7.233 × 10 ⁻⁵ | = Poundals |
| Dynes | ×2.248 × 10 ⁻⁶ | = Pounds |
| E | | |
| Eil | ×114.30 | = Centimeters |
| Eil | ×45 | = Inches |
| Em, pica | ×0.167 | = Inch |
| Em, pica | ×0.4233 | = Centimeter |
| Erg/second | ×1 | = Dyne-centimeter/second |
| Erg/second | ×1.0 × 10 ⁻⁷ | = Watt |
| Erg | ×9.480 × 10 ⁻¹¹ | = Btu |
| Erg | ×1 | = Dyne-centimeter |
| Erg | ×7.367 × 10 ⁻⁸ | = Foot-pounds |
| Erg | ×1.0 × 10 ⁻⁷ | = Joules |
| Expansion coefficient, °F | ×1.8 | = Expansion coefficient, °C |
| F | | |
| Fahrenheit minus 32° F | ×0.5556 | = Centigrade |
| Famm | ×5.8455 | = Foot, USA |
| Famm | ×1.7814 | = Meter |
| Faradays | ×26.8 | = Ampere-hour |
| Fathom, British | ×6.08 | = Feet |
| Fathom, British | ×1.8532 | = Meter |
| Fathom, USA | ×6 | = Feet |
| Fathom, USA | ×1.8288 | = Meter |
| Fathom, USA | ×2 | = Yard |
| Feet | ×30.48 | = Centimeters |
| Feet | ×1.645 × 10 ⁻⁴ | = Miles (nautical) |
| Feet, USA | ×0.3048 | = Meters |
| Feet, USA | ×0.3333 | = Yards |
| Feet, USA | ×0.18939 × 10 ⁻³ | = Miles, USA statute |
| Feet, USA | ×12 | = Inches |
| Feet, USA | ×1.2 × 10 ⁴ | = Mils |
| Feet, USA | ×0.0606 | = Rod |
| Feet of water | ×0.0295 | = Atmospheres |
| Feet of water | ×0.8826 | = Inches of mercury |
| Feet of water | ×0.03048 | = Kilograms/square centimeters |
| Feet of water | ×304.8 | = Kilograms/square meter |
| Feet of water | ×62.43 | = Pounds/square foot |
| Feet of water | ×0.4335 | = Pounds/square inch |
| Feet/hour | ×0.01666 | = Feet/minute |
| Feet/hour | ×0.2777 × 10 ⁻³ | = Feet/second |

APPENDIX D **867**

| | | |
|--------------------|------------------------------------|-----------------------------|
| Feet/hour | $\times 0.1894 \times 10^{-3}$ | = Miles/hour |
| Feet/minute | $\times 0.5080$ | = Centimeter/second |
| Feet/minute | $\times 0.01666$ | = Feet/second |
| Feet/minute | $\times 0.18288$ | = Kilometer/hour |
| Feet/minute | $\times 0.009868$ | = Knot |
| Feet/minute | $\times 0.3048$ | = Meter/minute |
| Feet/minute | $\times 0.00508$ | = Meter/second |
| Feet/minute | $\times 0.01136$ | = Mile/hour |
| Feet/minute | $\times 0.1894 \times 10^{-3}$ | = Mile/minute |
| Feet/second | $\times 30.48$ | = Centimeters/second |
| Feet/second | $\times 1.097$ | = Kilometers/hour |
| Feet/second | $\times 0.5921$ | = Knots |
| Feet/second | $\times 18.29$ | = Meters/minute |
| Feet/second | $\times 0.681818$ | = Miles/hour |
| Feet/second | $\times 0.0113636$ | = Miles/minute |
| Feet/second | $\times 3600$ | = Feet/hour |
| Feet/second | $\times 60$ | = Feet/minute |
| Feet/second/second | $\times 30.48$ | =Centimeters/second/second |
| Feet/second/second | $\times 1.097$ | = Kilometers/hour/second |
| Feet/second/second | $\times 0.3048$ | = Meters/second/second |
| Feet/second/second | $\times 0.6818$ | = Miles/hour/second |
| Feet/100 feet | $\times 1$ | = Percent grade |
| Firkin | $\times 9$ | = Gallon, liquid, USA |
| Firkin | $\times 34.06798$ | = Liter |
| Foot-candle | $\times 10.764$ | = Lumen/square meter |
| Foot-candle | $\times 1$ | = Lumen/square foot |
| Foot-candle | $\times 10.764$ | = Lux |
| Foot-candle | $\times 1.076$ | = Milliphot |
| Foot-candle | $\times 0.001076$ | = Phot |
| Foot-candle | $\times \text{distance in feet}^2$ | = Candlepower |
| Foot-Lambert | $\times 0.3425 \times 10^{-3}$ | = Candle/square centimeters |
| Foot-Lambert | $\times 0.3183$ | = Candle/square foot |
| Foot-Lambert | $\times 0.00221$ | = Candle/square inch |
| Foot-Lambert | $\times 0.001076$ | = Lambert |
| Foot-Lambert | $\times \text{square foot Area}$ | = Lumen |
| Foot-Lambert | $\times 1.076$ | = Millilambert |
| Foot-Lambert | $\times 0.342 \times 10^{-3}$ | = Stilb |
| Foot-pound | $\times 1.2853 \times 10^{-3}$ | = Btu |
| Foot-pound | $\times 1.356 \times 10^7$ | = Ergs |
| Foot-pound | $\times 0.32389$ | = Gram-calorie |
| Foot-pound | $\times 5.0505 \times 10^{-7}$ | = Horsepower-hours, USA |
| Foot-pound | $\times 5.12 \times 10^{-7}$ | = Horsepower-hours, metric |
| Foot-pound | $\times 12$ | = Inch-pound |
| Foot-pound | $\times 1.35582$ | = Joule absolute |
| Foot-pound | $\times 1.3554$ | = Joule international |
| Foot-pound | $\times 3.238 \times 10^{-4}$ | = Kilogram-calories |
| Foot-pound | $\times 0.1383$ | = Kilogram-meters |
| Foot-pound | $\times 3.766 \times 10^{-7}$ | = Kilowatt-hours |
| Foot-pound | $\times 0.001356$ | = Kilowatt-second |
| Foot-pound | $\times 0.01338$ | = Liter-atmosphere |
| Foot-pound | $\times 0.3766 \times 10^{-3}$ | = Watt-hour |
| Foot-pound | $\times 1.356$ | = Watt-second |
| Foot-pound/minute | $\times 0.077118$ | = Btu/hour |
| Foot-pound/minute | $\times 1.286 \times 10^{-3}$ | = Btu/minute |
| Foot-pound/minute | $\times 2.259 \times 10^5$ | = Erg/second |
| Foot-pound/minute | $\times 0.01666$ | = Foot-pound/second |
| Foot-pound/minute | $\times 3.066 \times 10^{-5}$ | = Horsepower, metric |
| Foot-pound/minute | $\times 3.0303 \times 10^{-5}$ | = Horsepower, USA |
| Foot-pound/minute | $\times 2.2597 \times 10^{-5}$ | = Kilowatt |
| Foot-pound/minute | $\times 0.022597$ | = Watt |
| Foot-pound/second | $\times 0.0771$ | = Btu/minute |
| Foot-pound/second | $\times 4.6263$ | = Btu/hour |
| Foot-pound/second | $\times 1.843 \times 10^{-3}$ | = Horsepower, metric |
| Foot-pound/second | $\times 1.818 \times 10^{-3}$ | = Horsepower, USA |
| Foot-pound/second | $\times 1.356$ | = Joule |
| Foot-pound/second | $\times 1.3558 \times 10^{-3}$ | = Kilowatts |
| Foot-pound/second | $\times 1.3558$ | = Watt |
| Fot | $\times 0.974$ | = Foot, USA |
| Fot | $\times 100$ | = Lines |
| Fot | $\times 0.2969$ | = Meter |

868 APPENDIX D

| | | |
|----------------------------------|----------------------------|-----------------------------------|
| Fot | ×10 | = Turn |
| Foute | ×1 | = Foot, USA |
| Furlong | ×6.6 | = Chain, engineer |
| Furlong | ×10 | = Chain, Gunter |
| Furlong | ×660 | = Feet |
| Furlong | ×201.168 | = Meters |
| Furlong | ×0.125 | = Mile, statue, USA |
| Furlong | ×220 | = Yards |
| Furlong | ×40 | = Rods |
| Fuss | ×0.9842 | = Foot, USA |
| Fuss | ×0.300 | = Meter |
| G | | |
| Gallon, British, Imperial Liquid | ×0.125 | = Bushel, dry, British |
| Gallon, British, Imperial Liquid | ×4546 | = Cubic centimeter |
| Gallon, British, Imperial Liquid | ×0.16046 | = Cubic foot |
| Gallon, British, Imperial Liquid | ×0.0045 | = Cubic meter |
| Gallon, British, Imperial Liquid | ×1.032 | = Gallon, dry, USA |
| Gallon, British, Imperial Liquid | ×1.20095 | = Gallon, liquid, USA |
| Gallon, British, Imperial Liquid | ×4.54596 | = Kilogram |
| Gallon, British, Imperial Liquid | ×10 | = Pound, water, 62° F |
| Gallon, dry, USA | ×0.125 | = Bushel, USA |
| Gallon, dry, USA | ×4404.92 | = Cubic centimeter |
| Gallon, dry, USA | ×0.155555 | = Cubic foot |
| Gallon, dry, USA | ×268.803 | = Cubic inch |
| Gallon, dry, USA | ×1.16365 | = Gallon, liquid, USA |
| Gallon, dry, USA | ×4.4049 | = Liter |
| Gallon, dry, USA | ×0.05 | = Peck |
| Gallon, dry, USA | ×8 | = Pint |
| Gallon, dry, USA | ×4.6546 | = Quart, liquid, USA |
| Gallon, liquid, USA | ×0.0238 | = Barrel, oil |
| Gallon, liquid, USA | ×3785.434 | = Cubic centimeter |
| Gallon, liquid, USA | ×3.785434 | = Cubic decimeter |
| Gallon, liquid, USA | ×0.13368 | = Cubic foot |
| Gallon, liquid, USA | ×231 | = Cubic inch, water, 62° F |
| Gallon, liquid, USA | ×3.7854 × 10 ⁻³ | = Cubic moter |
| Gallon, liquid, USA | ×4.951 × 10 ⁻³ | = Cubic yard |
| Gallon, liquid, USA | ×0.859365 | = Gallon, dry, USA |
| Gallon, liquid, USA | ×0.832673 | = Gallon, liquid, British |
| Gallon, liquid, USA | ×3.7853 | = Liter |
| Gallon, liquid, USA | ×8 | = Pint, liquid, USA |
| Gallon, liquid, USA | ×4 | = Quart, liquid, USA |
| Gallon, liquid, USA | ×8.3453 | = Pounds, water |
| Gallon/hour, USA | ×0.1337 | = Cubic feet/hour |
| Gallon/hour, USA | ×2.228 × 10 ⁻³ | = Cubic feet/minute |
| Gallon/hour, USA | ×0.01666 | = Gallons/minute |
| Gallon/hour, USA | ×2.777 × 10 ⁻⁴ | = Gallons/second |
| Gallon/minute, USA | ×34.2857 | = Barrels/day, oil |
| Gallon/minute, USA | ×1.42857 | = Barrels/hour, oil |
| Gallon/minute, USA | ×0.023809 | = Barrels/minute, oil |
| Gallon/minute, USA | ×192.49999 | = Cubic feet/day |
| Gallon/minute, USA | ×8.021 | = Cubic feet/hour |
| Gallon/minute, USA | ×0.13368 | = Cubic feet/minute |
| Gallon/minute, USA | ×2.228 × 10 ⁻³ | = Cubic feet/second |
| Gallon/minute, USA | ×0.2271 | = Cubic meters/hour |
| Gallon/minute, USA | ×1440 | = Gallons/day |
| Gallon/minute, USA | ×60 | = Gallons/hour |
| Gallon/minute, USA | ×0.01666 | = Gallons/second |
| Gallon/minute, USA | ×5.35565 | = Tonnes, long, water, 62° F/day |
| Gallon/minute, USA | ×5.99839 | = Tonnes, short, water, 62° F/day |
| Gallon/minute, USA | ×0.06308 | = Liters/second |
| Gallon/second, USA | ×481 | = Cubic feet/hour |
| Gallon/second, USA | ×8.02 | = Cubic feet/minute |
| Gallon/second, USA | ×0.1337 | = Cubic feet/second |
| Gallon/second, USA | ×60 | = Gallons/minute, USA |
| Gills, British | ×142.07 | = Cubic centimeter |
| Gills, British | ×0.1183 | = Liters |
| Gills, British | ×0.25 | = Pints, liquid |
| Grade | ×0.0025 | = Circle |

APPENDIX D 869

| | | |
|--------------------------|-----------------------------|----------------------------|
| Grade | ×9,000 | = Degree |
| Grade | ×54 | = Minute |
| Grade | ×0.01571 | = Radian |
| Grain | ×0.01666 | = Dram, apothecary |
| Grain | ×0.03657 | = Dram, avoirdupois |
| Grain (troy) | ×1 | = Grain (avdp) |
| Grain (troy) | ×0.0648 | = Grams |
| Grain (troy) | ×2.0833 × 10 ⁻³ | = Ounces (troy) |
| Grain (troy) | ×2.286 × 10 ⁻³ | = Ounces (avdp) |
| Grain/U.S. gallon | ×17.118 | = Parts/million |
| Grain/U.S. gallon | ×142.86 | = Pounds/million gallon |
| Grain/Imperial gallon | ×14.286 | = Parts/million |
| Gram | ×5 | = Carat |
| Gram | ×3.858 | = Carat, metric |
| Gram | ×100 | = Centigram |
| Gram | ×0.2572 | = Dram, apothecary |
| Gram | ×0.56438 | = Dram, avoirdupois |
| Gram | ×980.665 | = Dyne |
| Gram | ×15.4324 | = Grain |
| Gram | ×9.807 × 10 ⁻⁵ | = Joules/centimeters |
| Gram | ×9.807 × 10 ⁻³ | = Joules/meter (newtons) |
| Gram | ×0.001 | = Kilograms |
| Gram | ×1000 | = Milligrams |
| Gram | ×0.03527 | = Ounces, avoirdupois |
| Gram | ×0.03215 | = Ounces, troy |
| Gram | ×0.07093 | = Pounds |
| Gram | ×2.205 × 10 ⁻³ | = Pounds |
| Grams | ×1/MW | = Gram-mols |
| Grams/centimeter | ×5.6 × 10 ⁻³ | = Pounds/inch |
| Grams/cubic centimeter | ×62.43 | = Pounds/cubic foot |
| Grams/cubic centimeter | ×0.03613 | = Pounds/cubic foot |
| Grams/liter | ×58.417 | = Grains/gallon, USA |
| Grams/liter | ×8.345 | = Pounds/1,000 gallons |
| Grams/liter | ×0.062427 | = Pounds/cubic foot |
| Grams/liter | ×1,000 | = Parts/million |
| Grams/square centimeter | ×2.0481 | = Pounds/square foot |
| Gram-calories | ×3.968 × 10 ⁻³ | = Btu |
| Gram-calories | ×4.1868 × 10 ⁷ | = Ergs |
| Gram-calories | ×3.088 | = Foot-pounds |
| Gram-calories | ×1.55856 × 10 ⁻⁶ | = Horsepower/hours |
| Gram-calories | ×1.163 × 10 ⁻⁶ | = Kilowatt-hours |
| Gram-calories | ×1.163 × 10 ⁻³ | = Watt-hours |
| Gram/calories/ second | ×14.286 | = Btu/hour |
| Gram-centimeters | ×9.29658 × 10 ⁻⁸ | = Btu |
| Gram-centimeters | ×980.7 | = Ergs |
| Gram-centimeters | ×9.807 × 10 ⁻⁵ | = Joules |
| Gram-mol | ×22.414 | = Liters at 0° C and 1 atm |
| Gross | ×12 | = Dozen |
| Gross, great | ×144 | = Dozen |
| Gross, great | ×12 | = Gross |

H

| | | |
|-----------------------------|----------------------------|----------------------|
| Hand | ×10.16 | = Centimeter |
| Hand | ×4 | = Inch |
| Hand | ×48 | = Foot |
| Hand | ×1,016 | = Meter |
| Head, feet elevation, water | ×0.433 | = Pounds/square inch |
| Hectare | ×2.471 | = Acre |
| Hectare | ×100 | = Are |
| Hectare | ×1.07639 × 10 ⁵ | = Square feet |
| Hectare | ×0.01 | = Square kilometer |
| Hectare | ×10,000 | = Square meters |
| Hectare | ×3.861 × 10 ⁻³ | = Square miles |
| Hectare | ×11,960 | = Square yard |
| Hectogram | ×100 | = Gram |
| Hectoliter | ×3.532 | = Cubic feet |
| Hectoliter | ×0.1 | = Cubic meter |
| Hectoliter | ×0.1308 | = Cubic yard |

870 APPENDIX D

| | | |
|--------------------------|----------------------------|---------------------------|
| Hectoliter | ×26.42 | = Gallon, USA |
| Hectoliter | ×100 | = Liter |
| Hectometer | ×328.089 | = Feet |
| Hectometer | ×100 | = Meter |
| Hectometer | ×0.06214 | = Mile, statute, USA |
| Hectometer | ×109.36 | = Yard |
| Hectowatts | ×100 | = Watts |
| Henries | ×1,000 | = Millihenries |
| Hogsheads, British | ×10.114 | = Cubic feet |
| Hogsheads, USA | ×8.42184 | = Cubic feet |
| Hogsheads, USA | ×63 | = Gallons, USA |
| Hogsheads, USA | ×238.476 | = Liter |
| Hogsheads, USA | ×504 | = Pint |
| Hogsheads, USA | ×252 | = Quart |
| Horsepower, USA | ×42.44 | = Btu/minute |
| Horsepower, USA | ×33,000 | = Foot-pounds/minute |
| Horsepower, USA | ×550 | = Foot-pounds/second |
| Horsepower, USA | ×0.7457 | = Kilowatts |
| Horsepower, USA | ×1.014 | = Horsepower (metric) |
| Horsepower, boiler | ×33,479 | = Btu/hour |
| Horsepower, boiler | ×34.5 | = Pounds water/hour |
| Horsepower, boiler | ×9.803 | = Kilowatts |
| Horsepower, electric | ×0.7072 | = Btu/second |
| Horsepower, electric | ×746 | = Joule/second |
| Horsepower, electric | ×0.746 | = Kilowatts |
| Horsepower, electric | ×746 | = Watts |
| Horsepower (metric) | ×0.98632 | = Horsepower (USA) |
| Horsepower (metric) | ×542.5 | = Foot-pounds/second |
| Horsepower, hours, USA | ×2,547 | = Btu |
| Horsepower, hours, USA | ×2.6845 × 10 ¹³ | = Ergs |
| Horsepower, hours, USA | ×1.98 × 10 ⁶ | = Foot-pounds |
| Horsepower, hours, USA | ×641,190 | = Gram-calories |
| Horsepower, hours, USA | ×1.01387 | = Horsepower-hour, metric |
| Horsepower, hours, USA | ×2,376 × 10 ⁴ | = Inch-pounds |
| Horsepower, hours, USA | ×26.8453 × 10 ⁵ | = Joule |
| Horsepower, hours, USA | ×0.7457 | = Kilowatt-hour |
| Horsepower-hours, metric | ×2509.83 | = Btu |
| Horsepower-hours, metric | ×1.9529 × 10 ⁶ | = Foot-pounds |
| Horsepower-hours, metric | ×0.98632 | = Horsepower-hour, USA |
| Horsepower-hours, metric | ×632,467 | = Gram-calories |
| Horsepower-hours, metric | ×26.4761 | = Joule |
| Horsepower-hours, metric | ×0.73545 | = Kilowatt-hour |
| Hours | ×0.0417 | = Day |
| Hours | ×60 | = Minute |
| Hours | ×0.00137 | = Month |
| Hours | ×0.1142 × 10 ⁻³ | = Year |
| Hours | ×5.952 × 10 ⁻³ | = Week |
| Hundredweight (long) | ×112 | = Pounds |
| Hundredweight (long) | ×0.05 | = Tonnes, long |
| Hundredweight (short) | ×1.8 | = Cubic foot |
| Hundredweight (short) | ×45.36 | = Kilograms |
| Hundredweight (short) | ×100 | = Pounds |
| Hundredweight (short) | ×0.05 | = Ton, short |
| Hundredweight (short) | ×0.04536 | = Tonnes, metric |
| Hundredweight (short) | ×0.044643 | = Tonnes, long |

I

| | | |
|------|----------------------------|----------------------|
| Inch | ×254 × 10 ⁶ | = Angstrom |
| Inch | ×2.54 | = Centimeter |
| Inch | ×0.833 × 10 ⁻³ | = Chain, engineer |
| Inch | ×1.2626 × 10 ⁻³ | = Chain, Gunter |
| Inch | ×0.254 | = Decemeter |
| Inch | ×0.08333 | = Foot, USA |
| Inch | ×0.0254 | = Meter |
| Inch | ×1.578 × 10 ⁻⁵ | = Mile, statute, USA |
| Inch | ×25.4 | = Millimeters |
| Inch | ×1,000 | = Mils |
| Inch | ×5.05 × 10 ⁻³ | = Rods |
| Inch | ×0.02778 | = Yards |

APPENDIX D 871

| | | |
|-------------------|---------------------------|-------------------------------|
| Inch, mercury | ×0.03342 | = Atmospheres |
| Inch, mercury | ×1.133 | = Feet of water |
| Inch, mercury | ×13.61 | = Inch height, water |
| Inch, mercury | ×70.73 | = Pound/square foot |
| Inch, mercury | ×0.49116 | = Pound/square inch |
| Inch, mercury | ×0.03453 | = Kilograms/square centimeter |
| Inches of mercury | ×345.3 | = Kilograms/square meter |
| Inch-pound | ×1.07 × 10 ⁻⁴ | = Btu |
| Inch-pound | ×0.0833 | = Foot-pound |
| Inch, water, 4° C | ×2.458 × 10 ⁻³ | = Atmospheres |
| Inch, water, 4° C | ×0.07355 | = Inches of mercury |
| Inch, water, 4° C | ×2.54 × 10 ⁻³ | = Kilograms/square centimeter |
| Inch, water, 4° C | ×0.5781 | = Ounces/square inch |
| Inch, water, 4° C | ×5.204 | = Pounds/square foot |
| Inch, water, 4° C | ×0.03613 | =Pounds/square inch |

J

| | | |
|-------|---------------------------|--------------------|
| Joule | ×9.48 × 10 ⁻⁴ | = Btu |
| Joule | ×10 ⁷ | = Erg |
| Joule | ×0.7376 | = Foot-pound |
| Joule | ×2.389 × 10 ⁻⁴ | = Kilogram-calorie |
| Joule | ×1.0197 × 10 ⁴ | = Gram-centimeter |
| Joule | ×2.778 × 10 ⁻⁴ | = Watt-hours |

K

| | | |
|----------------------------------|----------------------------|--------------------------|
| Kilogram | ×1,000 | = Grams |
| Kilogram | ×70.93 | = Poundals |
| Kilogram | ×2.205 | = Pounds (avdp) |
| Kilogram | ×9.842 × 10 ⁻⁴ | = Tonnes, long |
| Kilogram | ×1.102 × 10 ⁻³ | = Tonnes, short |
| Kilogram | ×0.001 | = Tonnes, metric |
| Kilocalories | ×3.968 | = Btu |
| Kilocalories | ×3,088 | = Foot-lbs. |
| Kilocalories | ×1.56 × 10 ⁻³ | = Hp.-hrs. |
| Kilocalories | ×1.163 × 10 ⁻³ | = Kilowatt-hrs. |
| Kilocalories/square meter/hr/° C | ×0.205 | = Btu/square foot/hr/° F |
| Kilogram-meters | ×9.294 × 10 ⁻³ | = Btu |
| Kilograms/cubic meter | ×0.001 | = Grams/cubic centimeter |
| Kilograms/cubic meter | ×0.06243 | = Pounds/cubic foot |
| Kilograms/cubic meter | ×3.613 × 10 ⁻⁵ | = Pounds/cubic inch |
| Kilograms/cubic meter | ×3.405 × 10 ⁻¹⁰ | = Pounds/mil-foot |
| Kilograms/cubic meter | ×8.428 × 10 ⁻³ | = Ton, short/cubic yard |
| Kilograms/meter | ×10 | = Gram/centimeter |
| Kilograms/meter | ×391.983 | = Gram/inch |
| Kilograms/meter | ×0.672 | = Pounds/foot |
| Kilograms/meter | ×0.056 | = Pounds/inch |
| Kilograms/square centimeter | ×0.9678 | = Atmospheres |
| Kilograms/square centimeter | ×32.81 | = Feet of water |
| Kilograms/square centimeter | ×28.96 | = Inch of mercury |
| Kilograms/square centimeter | ×2,048 | = Pounds/square foot |
| Kilograms/square centimeter | ×14.223 | = Pounds/square inch |
| Kilograms/square meter | ×9.678 × 10 ⁻⁵ | = Atmospheres |
| Kilograms/square meter | ×3.281 × 10 ⁻³ | = Feet of water |
| Kilograms/square meter | ×2.896 × 10 ⁻³ | = Inches of mercury |
| Kilograms/square meter | ×0.03937 | = Inches of water |
| Kilograms/square meter | ×0.2048 | = Pounds/square foot |
| Kilograms/square meter | ×1.422 × 10 ⁻³ | = Pounds/square inch |
| Kilometers | ×3281 | = Feet |
| Kilometers | ×3.937 × 10 ⁴ | = Inches |
| Kilometers | ×1,000 | = Meters |
| Kilometers | ×0.6214 | = Miles (statute) |
| Kilometers | ×0.5295 | = Miles (nautical) |
| Kilometers | ×1,094 | = Yards |
| Kilometers/hour | ×27.78 | = Centimeters/second |
| Kilometers/hour | ×54.68 | = Feet/minute |
| Kilometers/hour | ×0.9113 | = Feet/second |

872 APPENDIX D

| | | |
|-----------------|--------------------------|---------------------------|
| Kilometers/hour | ×0.5396 | = Knots |
| Kilometers/hour | ×16.67 | = Meters/minute |
| Kilometers/hour | ×0.6214 | = Miles/hour |
| Kilowatts | ×56.92 | = Btu/minute |
| Kilowatts | ×1.35972 | = Horsepower, metric |
| Kilowatts | ×1.341 | = Horsepower, USA |
| Kilowatts | ×1,000 | = Watts |
| Kilowatts | ×4.426 × 10 ⁴ | = Foot-lbs./minute |
| Kilowatts | ×737.6 | = Foot-lbs./second |
| Kilowatt-hrs. | ×2.655 × 10 ⁶ | = Foot-lbs. |
| Kilowatt-hours | ×1000 | = Watt hours |
| Kilowatt-hours | ×3,413 | = Btu |
| Kilowatt-hours | ×3.6 × 10 ¹³ | = Ergs |
| Kilowatt-hours | ×1.36 | = Horsepower-hour, metric |
| Kilowatt-hours | ×1.341 | = Horsepower-hour, USA |
| Kilowatt-hours | ×3.6 × 10 ⁶ | = Joules |
| Kilowatt-hours | ×860.5 | = Kilogram-calories |
| Kilowatt-hours | ×3.671 × 10 ⁵ | = Kilogram-meters |
| Kilowatt-hours | ×3.53 | = Pounds of water* |
| Kilowatt-hours | ×22.75 | = Pounds of water† |
| Kip | ×1 | = Kilopound |
| Kip | ×1,000 | = Pound |
| Knott, USA | ×51.48 | = Centimeter/second |
| Knott, USA | ×6080.2 | = Feet/hour |
| Knott, USA | ×1.8532 | = Kilometer/hour |
| Knott, USA | ×30.887 | = Meter/minute |
| Knott, USA | ×1.15155 | = Mile/hour (statute) |
| Knott, USA | ×2027 | = Yards/hour |

L

| | | |
|--------------------|-----------------------------|-----------------------|
| League, land | ×24 | = Furlong |
| League, land | ×4.828 | = Kilometer |
| League, land | ×3 | = Mile |
| League, marine | ×5.56 | = Kilometer |
| League, marine | ×3 | = Mile, nautical |
| League, marine | ×3.45 | = Mile, statute |
| Light year | ×5.9 × 10 ¹² | = Miles |
| Light year | ×9.46091 × 10 ¹² | = Kilometers |
| Links, engineers' | ×12 | = Inches |
| Links, surveyors' | ×7.92 | = Inches |
| Links, surveyors' | ×0.66 | = Feet |
| Links, surveyors' | ×0.22 | = Yard |
| Liters | ×0.02838 | = Bushels, USA, dry |
| Liters | ×100 | = Centiliters |
| Liters | ×1,000 | = Cubic centimeters |
| Liters | ×0.035316 | = Cubic feet |
| Liters | ×61.02 | = Cubic inches |
| Liters | ×6.291 × 10 ⁻³ | = Barrels, oil, USA |
| Liters | ×61.027 | = Cubic inches |
| Liters | ×0.001 | = Cubic meter |
| Liters | ×1.308 × 10 ⁻³ | = Cubic yard |
| Liters | ×0.2642 | = Gallon, USA, liquid |
| Liters | ×0.2199 | = Gallons (Imperial) |
| Liters | ×1.7598 | = Pint, USA, dry |
| Liters | ×2.1134 | = Pint, USA, liquid |
| Liters | ×2.202 | = Pounds of water |
| Liters/minute | ×5.886 × 10 ⁻⁴ | = Cubic foot/second |
| Liters/minute | ×4.403 × 10 ⁻³ | = Gallons/second |
| Liters/second | ×2.1186 | = Cubic feet/minute |
| Lumen | ×0.07958 | = Candlepower |
| Lumen | ×1.47 × 10 ⁻³ | = Watt |
| Lumens/square foot | ×1 | = Foot-candles |
| Lux | ×0.0929 | = Foot-candles |

* Evaporated from and at 212° F

† Raised from 62° to 212° F

M

| | | |
|---------------------|-----------------------------|-----------------------|
| Maas | ×1.5 | = Liter |
| Meter | ×10 ¹⁰ | = Angstrom units |
| Meter | ×100 | = Centimeter |
| Meter | ×3.2808 | = Feet, USA |
| Meter | ×0.01 | = Hectometer |
| Meter | ×39.37 | = Inches |
| Meter | ×0.001 | = Kilometer |
| Meter | ×5.396 × 10 ⁻⁴ | = Miles, nautical |
| Meter | ×6.214 × 10 ⁻⁴ | = Miles, statute |
| Meter | ×1000 | = Millimeters |
| Meter | ×1.094 | = Yards |
| Meter | ×1.179 | = Vara |
| Meters/minute | ×1.667 | = Centimeters/second |
| Meters/minute | ×3.281 | = Feet/minute |
| Meters/minute | 0.05468 | = Feet/second |
| Meters/minute | ×0.06 | = Kilometers/hour |
| Meters/minute | ×0.03238 | = Knots |
| Meters/minute | ×0.03728 | = Miles/hour |
| Meters/second | ×196.8 | = Feet/minute |
| Meters/second | ×3.281 | = Feet/second |
| Meters/second | ×3.6 | = Kilometers/hour |
| Meters/second | ×0.06 | = Kilometers/minute |
| Meters/second | ×2.237 | = Miles/hour |
| Meters/second | ×0.03728 | = Miles/minute |
| Microns | ×39.37 × 10 ⁻⁶ | = Inches |
| Microns | ×1 × 10 ⁻⁶ | = Meters |
| Micron | ×0.0001 | = Centimeter |
| Micron | ×1000 | = Millimicron |
| Mile, USA, nautical | ×6,080.2 | = Feet, USA |
| Mile, USA, nautical | ×6,080 | = Feet, British |
| Mile, USA, nautical | ×72,962.5 | = Inches |
| Mile, USA, nautical | ×1.853 | = Kilometer |
| Mile, USA, nautical | ×0.333 | = League |
| Mile, USA, nautical | ×1,853.248 | = Meter |
| Mile, USA, nautical | ×1.15155 | = Mile, USA, statute |
| Mile, USA, nautical | ×2,026.73 | = Yard |
| Mile, USA, statute | ×5,280 | = Feet, USA |
| Miles, USA, statute | ×8 | = Furlongs |
| Miles, USA, statute | ×63,360 | = Inches |
| Miles, USA, statute | ×1.60935 | = Kilometer |
| Miles, USA, statute | ×8,000 | = Link |
| Miles, USA, statute | ×1,609.35 | = Meters |
| Miles, USA, statute | ×0.8684 | = Mile, USA, nautical |
| Miles, USA, statute | ×1,900.8 | = Vara |
| Miles, USA, statute | ×1,706 | = Yard |
| Miles/hour | ×44.7 | = Centimeters/second |
| Miles/hour | ×88 | = Feet/minute |
| Miles/hour | ×1.467 | = Feet/second |
| Miles/hour | ×1.609 | = Kilometers/hour |
| Miles/hour | ×0.02682 | = Kilometers/minute |
| Miles/hour | ×0.8684 | = Knots |
| Miles/hour | ×26.82 | = Meters/minute |
| Miles/hour | ×0.4470 | = Meters/second |
| Miles/hour | ×0.01667 | = Miles/minute |
| Miles/minute | ×5,280 | = Feet/minute |
| Miles/minute | ×316,800 | = Feet/hour |
| Miles/minute | ×88 | = Feet/second |
| Miles/minute | ×60 | = Miles/hour |
| Miles/minute | ×1.609 | = Kilometers/minute |
| Miles/minute | ×0.8684 | = Knots/minute |
| Millimeter | ×0.1 | = Centimeter |
| Millimeter | ×3.281 × 10 ⁻³ | = Feet |
| Millimeter | ×0.03937 × 10 ⁻² | = Inches |
| Millimeter | ×10 ⁻⁶ | = Kilometers |
| Millimeter | ×0.001 | = Meters |
| Millimeter | ×6.214 × 10 ⁻⁷ | = Miles |
| Millimeter | ×39.37 | = Mils |
| Millimeter | ×1.094 × 10 ⁻³ | = Yards |
| Million gallons/day | ×1.54723 | = Cubic feet/second |

874 APPENDIX D

| | | |
|--------------------|--------------------------------|-------------------------------|
| Mils | $\times 2.540 \times 10^{-3}$ | = Centimeters |
| Mils | $\times 8.333 \times 10^{-5}$ | = Feet |
| Mils | $\times 0.001$ | = Inches |
| Mils | $\times 2.540 \times 10^{-8}$ | = Kilometers |
| Mils | $\times 2.778 \times 10^{-5}$ | = Yards |
| N | | |
| Nail | $\times 2.5$ | = Inch |
| Nepers | $\times 8.686$ | = Decibels |
| Newton | $\times 1 \times 10^5$ | = Dynes |
| O | | |
| Ounces (avdp) | $\times 16$ | = Drams |
| Ounces (avdp) | $\times 437.5$ | = Grains |
| Ounces (avdp) | $\times 28.349527$ | = Grams |
| Ounces (avdp) | $\times 0.0625$ | = Pounds |
| Ounces (avdp) | $\times 0.9115$ | = Ounces, troy |
| Ounces | $\times 2.79 \times 10^{-5}$ | = Tonnes, long |
| Ounces | $\times 2.835 \times 10^{-5}$ | = Tonnes, metric |
| Ounces, fluid | $\times 1.805$ | = Cubic inches |
| Ounces, fluid | $\times 0.02957$ | = Liters |
| Ounces, troy | $\times 480$ | = Grains |
| Ounces, troy | $\times 31.103481$ | = Grams |
| Ounces, troy | $\times 1.09714$ | = Ounces, avoirdupois |
| Ounces, troy | $\times 0.08333$ | = Pounds, troy |
| Ounces/square inch | $\times 0.0625$ | = Pounds/square inch |
| P | | |
| Parsec | $\times 19 \times 10^{12}$ | = Miles, USA, statute |
| Parsec | $\times 3.084 \times 10^{13}$ | = Kilometers |
| Parts/million | $\times 0.05833$ | = Grains/gallon, USA |
| Parts/million | $\times 0.07016$ | = Grains/gallon, British |
| Parts/million | $\times 8.345$ | = Pounds/million gallons, USA |
| Peck, British | $\times 554.6$ | = Cubic inches |
| Peck, British | $\times 2$ | = Gallons, British |
| Peck, British | $\times 9.0919$ | = Liters |
| Peck, USA | $\times 0.25$ | = Bushels |
| Peck, USA | $\times 537.605$ | = Cubic inches |
| Peck, USA | $\times 8.809582$ | = Liters |
| Peck, USA | $\times 8$ | = Quarts, dry |
| Peck, USA | $\times 9.3092$ | = Quarts, liquid |
| Pennyweights, troy | $\times 24$ | = Grains |
| Pennyweights, troy | $\times 0.05$ | = Ounces, troy |
| Pennyweights, troy | $\times 1.55517$ | = Grams |
| Pennyweights, troy | $\times 4.1667 \times 10^{-3}$ | = Pounds, troy |
| Percent | $\times 10^4$ | = Parts/million |
| Pfund, Germany | $\times 500$ | = Gram |
| Pint, USA, dry | $\times 0.015625$ | = Bushel |
| Pint, USA, dry | $\times 550.6136$ | = Cubic centimeter |
| Pint, USA, dry | $\times 0.01945$ | = Cubic feet |
| Pint, USA, dry | $\times 33.6$ | = Cubic inches |
| Pint, USA, dry | $\times 2$ | = Cup |
| Pint, USA, dry | $\times 0.125$ | = Gallon, USA, dry |
| Pint, USA, dry | $\times 0.145545$ | = Gallon, USA, liquid |
| Pint, USA, dry | $\times 0.5506$ | = Liter |
| Pint, USA, dry | $\times 0.0625$ | = Peck |
| Pint, USA, dry | $\times 0.5$ | = Quart, USA, dry |
| Pint, USA, dry | $\times 0.58182$ | = Quart, USA, liquid |
| Pint, USA, liquid | $\times 437.2$ | = Cubic centimeters |
| Pint, USA, liquid | $\times 0.01671$ | = Cubic feet |
| Pint, USA, liquid | $\times 28.875$ | = Cubic inch |
| Pint, USA, liquid | $\times 2$ | = Cup |
| Pint, USA, liquid | $\times 0.1074$ | = Gallon, USA, dry |
| Pint, USA, liquid | $\times 0.125$ | = Gallon, USA, liquid |

APPENDIX D 875

| | | |
|------------------------|----------------------------|---------------------------------|
| Pint, USA, liquid | ×4 | = Gill |
| Pint, USA, liquid | ×0.4732 | = Liters |
| Pint, USA, liquid | ×16 | = Ounces |
| Pint, USA, liquid | ×0.5 | = Quarts, USA, liquid |
| Pint, USA, liquid | ×0.42968 | = Quarts, USA, dry |
| Pint, USA, liquid | ×128 | = Dram, fluid |
| Poise | ×100 | = Centipoise |
| Pole | ×16.5 | = Feet |
| Pole | ×5.0292 | = Meter |
| Pole | ×1 | = Rod |
| Pole | ×5.5 | = Yard |
| Ponce | ×2.71 | = Centimeter |
| Pood | ×1,000 | = Cubic inch |
| Pood | ×40 | = Funt |
| Pood | ×4.32 | = Gallon, USA |
| Pood | ×16.3805 | = Kilogram |
| Poundals | ×13,826 | = Dynes |
| Poundals | ×14.098 | = Grams |
| Poundals | ×1.383 × 10 ⁻³ | = Joules/centimeter |
| Poundals | ×0.1383 | = Joules/meter |
| Poundals | ×0.0141 | = Kilograms |
| Poundals | ×0.1383 | = Newton |
| Poundals | ×0.03108 | = Pound-force |
| Pound-mol | ×359.05 | = Cubic feet at 32° F and 1 atm |
| Pounds | ×1/Mol. Wt. | = Pound-mols |
| Pounds | ×2267.9616 | = Carats |
| Pounds (avdp) | ×256 | = Drams |
| Pounds (avdp) | ×7,000 | = Grains |
| Pounds (avdp) | ×453.5924 | = Grams (metric) |
| Pounds | ×0.04448 | = Joules/centimeters |
| Pounds (avdp) | ×0.4536 | = Kilograms |
| Pounds (avdp) | ×16 | = Ounces |
| Pounds (avdp) | ×14.5833 | = Ounces, troy |
| Pounds | ×32.174 | = Poundals |
| Pounds (avdp) | ×1.21528 | = Pounds, troy |
| Pounds | ×4.464 × 10 ⁻⁴ | = Tons, long |
| Pounds | ×4.536 × 10 ⁻⁴ | = Tonnes, metric |
| Pounds | ×5 × 10 ⁻⁴ | = Tonnes, short |
| Pounds, troy | ×5,760 | = Grains |
| Pounds, troy | ×373.24177 | = Grams |
| Pounds, troy | ×13.1657 | = Ounces, avoirdupois |
| Pounds, troy | ×12 | = Ounces, troy |
| Pounds, troy | ×240 | = Pennyweights, troy |
| Pounds, troy | ×0.822857 | = Pounds, avoirdupois |
| Pounds, troy | ×3.6735 × 10 ⁻⁴ | = Tonnes, long |
| Pounds, troy | ×3.7324 × 10 ⁻⁴ | = Tonnes, metric |
| Pounds, troy | ×4.1143 × 10 ⁻⁴ | = Tonnes, short |
| Pounds of water | ×0.01602 | = Cubic feet |
| Pounds of water | ×27.68 | = Cubic inches |
| Pounds of water | ×0.1198 | = Gallons |
| Pounds of water/minute | ×2.67 × 10 ⁻⁴ | = Cubic feet/second |
| Pounds/cubic foot | ×0.01602 | = Grams/cubic centimeters |
| Pounds/cubic foot | ×16.02 | = Kilograms/cubic meter |
| Pounds/cubic foot | ×5.787 × 10 ⁻⁴ | = Pounds/cubic inch |
| Pounds/cubic foot | ×27 | = Pounds/cubic yard |
| Pounds/cubic inch | ×27.68 | = Grams/cubic centimeter |
| Pounds/cubic inch | ×2.768 × 10 ⁴ | = Kilograms/cubic meter |
| Pounds/cubic inch | ×1,728 | = Pounds/cubic foot |
| Pounds/cubic inch | ×46,656 | = Pounds/cubic yard |
| Pounds/hour | ×10.714 × 10 ⁻³ | = Tonnes/day, long |
| Pounds/hour | ×12 × 10 ⁻³ | = Tonnes/day, short |
| Pounds/hour | ×10.886 × 10 ⁻³ | = Tonnes/day, metric |
| Pounds/hour | ×0.45359 | = Kilograms/hour |
| Pounds/square foot | ×4.725 × 10 ⁻⁴ | = Atmospheres |
| Pounds/square foot | ×0.01602 | = Feet of water |
| Pounds/square foot | ×0.01414 | = Inches of mercury |
| Pounds/square foot | ×4.8824 | = Kilograms/square meter |
| Pounds/square foot | ×0.1111 | = Ounce/square inch |
| Pounds/square foot | ×0.107638 | = Pound/square centimeter |
| Pounds/square foot | ×6.944 × 10 ⁻³ | = Pound/square inch |
| Pounds/square foot | ×10.76387 | = Pound/square meter |

876 APPENDIX D

| | | |
|--------------------|-----------|------------------------------|
| Pounds/square inch | ×0.068046 | = Atmospheres |
| Pounds/square inch | ×2.307 | = Feet of water |
| Pounds/square inch | ×27.7 | = Inch of water |
| Pounds/square inch | ×2.036 | = Inch of mercury |
| Pounds/square inch | ×0.0703 | = Kilogram/square centimeter |
| Pounds/square inch | ×703.1 | = Kilogram/square meter |
| Pounds/square inch | ×51.714 | = Millimeters of mercury |
| Pounds/square inch | ×2,304 | = Ounce/square foot |
| Pounds/square inch | ×144 | = Pound/square foot |

Q

| | | |
|---------------------|----------------------------|----------------------|
| Quadrant | ×0.25 | = Circumference |
| Quadrant | ×90 | = Degrees |
| Quadrant | ×5,400 | = Minutes |
| Quadrant | ×1.571 | = Radians |
| Quarts, USA, dry | ×0.03125 | = Bushel |
| Quarts, USA, dry | ×1,101.2 | = Cubic centimeter |
| Quarts, USA, dry | ×0.03889 | = Cubic foot |
| Quarts, USA, dry | ×67.20 | = Cubic inches |
| Quarts, USA, dry | ×1.1012 | = Liter |
| Quarts, USA, dry | ×1.16365 | = Quart, USA, liquid |
| Quarts, USA, liquid | ×946.331 | = Cubic centimeter |
| Quarts, USA, liquid | ×0.03342 | = Cubic foot |
| Quarts, USA, liquid | ×57.75 | = Cubic inches |
| Quarts, USA, liquid | ×9.464 × 10 ⁻⁴ | = Cubic meters |
| Quarts, USA, liquid | ×1.238 × 10 ⁻³ | = Cubic yard |
| Quarts, USA, liquid | ×4 | = Cup |
| Quarts, USA, liquid | ×256 | = Dram fluid |
| Quarts, USA, liquid | ×0.25 | = Gallons |
| Quarts, USA, liquid | ×0.946331 | = Liter |
| Quarts, USA, liquid | ×5.9523 × 10 ⁻³ | = Oil, barrel |
| Quarts, USA, liquid | ×32 | = Ounces |
| Quarts, USA, liquid | ×2 | = Pint |
| Quarts, USA, liquid | ×0.8594 | = Quart, USA, dry |

R

| | | |
|--------------------|--------------------------|----------------------|
| Radians | ×57.3 | = Degrees |
| Radians | ×3,438 | = Minutes |
| Radians | ×0.6366 | = Quadrants |
| Radians | ×2.063 × 10 ⁵ | = Seconds |
| Revolutions/minute | ×6.0 | = Degrees/second |
| Revolutions/minute | ×0.1047 | = Radians/second |
| Revolutions/minute | ×0.01667 | = Revolutions/second |
| Rod | ×0.165 | = Chain, engineer |
| Rod | ×0.25 | = Chain, Gunter's |
| Rod | ×16.5 | = Foot |
| Rod | ×0.025 | = Furlong |
| Rod | ×198 | = Inch |
| Rod | ×25 | = Link |
| Rod | ×5.029 | = Meter |
| Rod | ×5.5 | = Yard |

S

| | | |
|-------------------|---------------------------|-----------------------|
| Seconds, angle | ×2.778 × 10 ⁻⁴ | = Degrees |
| Seconds, angle | ×16.67 × 10 ⁻³ | = Minutes |
| Seconds, time | ×2.777 × 10 ⁻⁴ | = Hour |
| Seconds, time | ×0.166 | = Minutes |
| Slugs | ×14.59 | = Kilograms |
| Slugs | ×32.17 | = Pounds |
| Slugs/cubic foot | ×0.5154 | = Gm/cubic centimeter |
| Snow, cubic foot | ×7.2 | = Pounds, 32° F |
| Snow, inch deep | ×0.1 | = Inch, water |
| Square centimeter | ×1.076 × 10 ⁻³ | = Square foot |
| Square centimeter | ×0.155 | = Square inch |

APPENDIX D **877**

| | | |
|--------------------|----------------------------|----------------------|
| Square centimeter | ×0.0001 | = Square meter |
| Square centimeter | ×3.861 × 10 ⁻¹¹ | = Square miles |
| Square centimeter | ×100 | = Square millimeters |
| Square centimeter | ×1.196 × 10 ⁻⁴ | = Square yards |
| Square feet, USA | ×2.296 × 10 ⁻⁵ | = Acre |
| Square feet, USA | ×9.29 × 10 ⁻⁴ | = Are |
| Square feet, USA | ×929.034 | = Square centimeters |
| Square feet, USA | ×144 | = Square inches |
| Square feet, USA | ×0.0929 | = Square meter |
| Square feet, USA | ×3.587 × 10 ⁻⁸ | = Square miles |
| Square feet, USA | ×9.29 × 10 ⁴ | = Square millimeters |
| Square feet, USA | ×0.1111 | = Square yards |
| Square inches | ×6.452 | = Square centimeters |
| Square inches | ×6.944 × 10 ⁻³ | = Square feet |
| Square inches | ×645.2 | = Square millimeters |
| Square inches | ×7.716 × 10 ⁻⁴ | = Square yard |
| Square kilometer | ×247.1 | = Acre |
| Square kilometer | ×100 | = Hectare |
| Square kilometer | ×10.76 × 10 ⁶ | = Square feet |
| Square kilometer | ×1.55 × 10 ⁹ | = Square inches |
| Square kilometer | ×10 ⁶ | = Square meters |
| Square kilometer | ×0.3861 | = Square mile, USA |
| Square kilometer | ×1.196 × 10 ⁶ | = Square yards |
| Square meters | ×2.471 × 10 ⁻⁴ | = Acre |
| Square meters | ×0.01 | = Are |
| Square meters | ×0.0001 | = Hectare |
| Square meters | ×10,000 | = Square centimeters |
| Square meters | ×10.764 | = Square feet |
| Square meters | ×1,550 | = Square inches |
| Square meters | ×3.861 × 10 ⁻⁷ | = Square miles |
| Square meters | ×1.196 | = Square yards |
| Square miles | ×640 | = Acre |
| Square miles | ×259 | = Hectare |
| Square miles | ×27.88 × 10 ⁶ | = Square feet |
| Square miles | ×2.59 | = Square kilometers |
| Square miles | ×2.59 × 10 ⁶ | = Square meters |
| Square miles | ×3.098 × 10 ⁶ | = Square yards |
| Square millimeters | ×0.01 | = Square centimeters |
| Square millimeters | ×1.076 × 10 ⁻⁵ | = Square feet |
| Square millimeters | ×1.55 × 10 ⁻³ | = Square inches |
| Square rods | ×0.00625 | = Acre |
| Square rods | ×272.25 | = Square feet |
| Square rods | ×25.293 | = Square meter |
| Square rods | ×30.25 | = Square yard |
| Square vara | ×7.716 | = Square feet |
| Square yard | ×2.066 × 10 ⁻⁴ | = Acres |
| Square yard | ×8361 | = Square centimeter |
| Square yard | ×9 | = Square feet |
| Square yard | ×1,296 | = Square inches |
| Square yard | ×0.8361 | = Square meters |
| Square yard | ×3.228 × 10 ⁻⁷ | = Square miles |
| Square yard | ×8.361 × 10 ⁵ | = Square millimeters |
| Square yard | ×0.03306 | = Square rods |
| Stone | ×14 | = Pound |
| Stone | ×6.35 | = Kilogram |

T

| | | |
|-------------------------|---------|-----------------------|
| Tablespoon | ×0.0625 | = Cup |
| Tablespoon | ×3 | = Teaspoon |
| Teaspoon | ×0.0208 | = Cup |
| Teaspoon | ×0.333 | = Tablespoon |
| Temperature, °C + 17.78 | ×1.8 | = ° F |
| Temperature, °F - 32 | ×0.5556 | = ° C |
| Ton, long | ×1,016 | = Kilogram |
| Ton, long | ×2,240 | = Pounds |
| Ton, long | ×1.016 | = Metric tonnes |
| Ton, long | ×1.12 | = Short tonnes |
| Ton, metric | ×7.454 | = Barrel, oil, 36 API |

878 APPENDIX D

| | | |
|---------------------------|------------|--------------------------|
| Ton, metric | ×1,000 | = Kilograms |
| Ton, metric | ×2,205 | = Pounds |
| Ton, metric | ×0.9842 | = Ton, long |
| Ton, metric | ×1.1023 | = Ton, short |
| Ton, shipping, USA | ×40 | = Cubic feet |
| Ton, shipping, USA | ×2.8317 | = Cubic meter |
| Ton, shipping, USA | ×1.050 | = Ton, shipping, British |
| Ton, short | ×40 | = Cubic feet |
| Ton, short | ×268.8 | = Gallons, USA, liquid |
| Ton, short | ×4 | = Hogshead |
| Ton, short | ×907.18486 | = Kilograms |
| Ton, short | ×1,000 | = Liter |
| Ton, short | ×32,000 | = Ounces |
| Ton, short | ×2,000 | = Pounds |
| Ton, short | ×0.89286 | = Tonnes, long |
| Ton, short | ×0.907 | = Tonnes, metric |
| Tonnes, short/square foot | ×9,765 | = Kilograms/square meter |
| Tonnes, short/square foot | ×2,000 | = Pounds/square inch |
| Tonnes, short/day | ×83.333 | = Pounds/hour |
| Tonnes, short/day | ×0.16643 | = Gallons/minute |
| Tonnes, short/day | ×0.9072 | = Tonnes, metric/day |
| Tonnes, short/day | ×0.8929 | = Tonnes, long/day |
| Tonnes, short/day | ×37.8 | = Kilograms/hour |
| Tonnes, metric/day | ×91.859 | = Pounds/hour |
| Tonnes, metric/day | ×41.667 | = Kilograms/hour |
| Tonnes, metric/day | ×0.9843 | = Tonnes, long/day |
| Tonnes, metric/day | ×1.1023 | = Tonnes, short/day |
| Tonnes, long/day | ×1.12 | = Tonnes, short/day |
| Tonnes, long/day | ×1.016 | = Tonnes, metric/day |
| Tonnes, long/day | ×93.333 | = Pounds/hour |
| Tonnes, long/day | ×42.335 | = Kilograms/hour |

V

| | | |
|-----------|----------|-------------------|
| Vara | ×2.7777 | = Feet |
| Vara | ×33.3333 | = Inch |
| Vara | ×0.9259 | = Yard |
| Volt/inch | ×0.3937 | = Volt/centimeter |

W

| | | |
|------------------------|----------------------------|--------------------------------|
| Water, 62° F, Gallon | ×8.3311 | = Pound |
| Water height in feet | ×0.4335 | = Pound/square inch |
| Water height in feet | ×0.03048 | = Kilograms/square centimeters |
| Water height in inches | ×0.03613 | = Pound/square inch |
| Water height in inches | ×0.00254 | = Kilograms/square centimeter |
| Water height in meters | ×1.42067 | = Pound/square inch |
| Water height in meters | ×0.100 | = Kilograms/square centimeters |
| Watts | ×3.4128 | = Btu/hour |
| Watts | ×0.05688 | = Btu/minute |
| Watts | ×107 | = Ergs/second |
| Watts | ×44.27 | = Foot-pounds/minute |
| Watts | ×0.7378 | = Foot-pounds/second |
| Watts | ×1.341 × 10 ⁻³ | = Horsepower, USA |
| Watts | ×1.36 × 10 ⁻³ | = Horsepower, metric |
| Watts | ×0.001 | = Kilowatt |
| Watts | ×1 | = Joules/second |
| Watts (abs.) | ×0.056884 | = Btu (mean)/minute |
| Watt-hours | ×3.4128 | = Btu |
| Watt-hours | ×3.60 × 10 ¹⁰ | = Ergs |
| Watt-hours | ×2,656 | = Foot-pounds |
| Watt-hours | ×858.85 | = Gram-calories |
| Watt-hours | ×1.341 × 10 ⁻³ | = Horsepower-hours, USA |
| Watt-hours | ×1.3596 × 10 ⁻³ | = Horsepower-hours, metric |
| Watt-hours | ×0.8605 | = Kilogram-calories |
| Watt-hours | ×367.2 | = Kilogram-meters |
| Watt-hours | ×0.001 | = Kilowatt-hours |

Y

| | | |
|-----------|-------------------------------|-----------------------|
| Yard, USA | $\times 91.4402$ | = Centimeter |
| Yard, USA | $\times 3$ | = Feet |
| Yard, USA | $\times 36$ | = Inch |
| Yard, USA | $\times 9.144 \times 10^{-4}$ | = Kilometer |
| Yard, USA | $\times 0.9144$ | = Meter |
| Yard, USA | $\times 4.934 \times 10^{-4}$ | = Mile, nautical, USA |
| Yard, USA | $\times 5.682 \times 10^{-4}$ | = Mile, Statute, USA |
| Yard, USA | $\times 914.402$ | = Millimeters |
| Yard, USA | $\times 0.1818$ | = Rod |
| Year | $\times 8,765$ | = Hours |
| Year | $\times 525,948$ | = Minutes |

D-2 Physical Property Conversion Factors

Acceleration of gravity = 32.172 ft./sec./sec.
= 980.6 cm./sec./sec.

Electrical conductance;

1 mho = 1 ohm⁻¹
= 10⁻⁶ megamho
= 10⁶ micromho

Heat Value of Fuel

Lower heating value
= Higher heating value - 10.3 (9H₂ + H₂O), Btu/lb.

where: H₂ = weight % hydrogen in fuel

H₂O = weight % water vapor in fuel

GPM = (pounds/hour) / (500 × Sp.Gr.)

Velocity, feet/sec. = $\frac{0.321 \text{ (GPM)}}{\text{(Flow Area, sq.in.)}}$

Head, feet = 2.31 (Pressure or head, psi) / Sp.Gr.

Brake horsepower, BHP = $\frac{\text{(GPM)} \text{ (Sp.Gr.)} \text{ (Head, feet)}}{3960 \text{ (Efficiency, fraction)}}$

Weight/Volume (avoirdupois unless otherwise stated)

Density of sea water = 1.025 grams/cc.

1 gram-molecular volume of a gas at 760 mm Hg and 0° C. = 22.4 liters

1 U. S. gallon = (8.34 × Sp.Gr. of fluid), pounds

Weight of one cu.ft. liquid = (62.32 pounds × Sp.Gr. of fluid), pounds/cu.ft.

1 pound avoirdupois = 1.2153 pound apothecaries'

1 grain avoirdupois = 1 grain troy = 1 grain apothecaries' weight

Air Analysis*

| | By Weight % | By Volume % |
|----------|-------------|-------------|
| Nitrogen | 75.47 | 78.2 |
| Oxygen | 23.19 | 21.0 |

* Neglects trace gases such as argon, xenon, helium, krypton and assumes dry basis.

Gas Constants, (R), Universal

R = 0.0821 (atm) (liter) / (g-mol) (°K)
= 1.987 (g-cal.) / (g-mol) (°K)
= 1.987 Btu / (lb.-mol) (°R)
= 1.987 (Chu) / (lb.-mol) (°K)
= 8.314 joules / (g-mol) (°K)
= 1,546 (ft.) (lb.force) / (lb.-mol) (°R)

= 10.73 (lb.-force/sq. in. abs.) (cu.ft.) / (lb.-mol) (°R)
= 18,510 (lb.-force/sq.in.) (cu.in.) / (lb.-mol) (°R)
= 0.7302 (Atm) (cu.ft.) / (lb.-mol) (°R)

R_i = R/mol.wt. gas

where: R_i = individual gas constant

Avogadro Constant, N_a = 6.02252 × 10²³ molecules/mol

Density Vapor or Gases (Ideal), ρ

$$\rho = \left(\frac{\text{mol. wt., vapor}}{359} \right) \left(\frac{14.7 + p}{14.7} \right) \left(\frac{460 + 32}{460 + ^\circ\text{F}} \right), \text{ lbs./cu.ft.}$$

where: p = gage pressure at actual condition, psig
°F = fahrenheit temperature at actual condition

$$\rho = \frac{144 P}{R_i T}, \text{ pounds/cu.ft.}$$

where: P = absolute pressure, pounds/sq. in. abs.

T = absolute temperature, °Rankine, °R

o = standard conditions (0°C & 760 mm Hg)

V = V_o (P_o/P°) (T/T_o)

P°V = 1543 nT; P° = PSF abs.; V = cu. ft.

T = °R; n = Lb. moles

$$\text{cu.ft.} = \frac{\text{lb}}{\text{MW}} (359) \left(\frac{273 + ^\circ\text{C}}{273} \right) \left(\frac{14.7}{p + 14.7} \right) \text{ at } p, ^\circ\text{C}$$

Specific Volume, Gas or Vapor

$$\bar{V} = 1/\rho, \text{ cu.ft./pound}$$

Velocity of sound in dry air @ 0° C. and 1 atm. = 1,089 ft./sec.

Density of dry air @ 0° C. and 1 atm.

= 0.001293 gm/cu.cm.

= 0.0808 lb./cu.ft.

Viscosity (Dynamic)

1 Poise = 1 gram/cm.-sec. = 1 dyne-sec./sq.cm.

= 0.1 kg/meter-sec.

1 Poise × 100 = Centipoise (μ)

Poise × 2.09 × 10⁻³ = slugs/ft.-sec.

= pounds (force)-sec./sq.ft.

Poise × 0.10 = pascal-sec.

D-2 Physical Property Conversion Factors

Poise $\times 0.0672 =$ pounds (mass)/(ft.-sec.)
= poundal-sec./sq.ft.

Poise $\times 0.10 =$ Newton-sec./sq. meter

Centipoise $\times 0.01 =$ gm./cm.-sec.

Centipoise $\times 6.72 \times 10^{-4} =$ pound/ft.-sec.

Centipoise $\times 2.4 =$ pound/ft.-hr.

Millipoise $\times 1000 =$ poise

Micropoise $\times 1,000,000 =$ poise

Slugs/ft.-sec. $\times 47,900 =$ centipoise

1 centistoke $= 1.076 \times 10^{-5}$ ft.²/sec.

1 centipoise (cp) $= 0.01$ gm./cm. sec.

Slugs/ft.-sec. $\times 32.2 =$ pounds (mass)/ft.-sec.

Pounds/ft.-sec. $\times 3600 =$ lb./ft.-hr.

Pounds (mass)/ft.-sec. $\times 1487 =$ centipoise

Pounds (mass)/ft.-sec. $\times 0.0311 =$ slugs/ft.-sec.
= pounds (force)-sec./sq.ft.

Viscosity of air @ 68° F. $= 180.8 \times 10^{-6}$ poise

Viscosity of water @ 66° F $= 0.010087$ poise

Viscosity (Kinematic)

Kinematic viscosity,

centistokes $\times 1.076 \times 10^{-5} =$ ft.²/sec.

Kinematic viscosity, centistokes (ν) $= \frac{\text{Dynamic viscosity, centipoise}}{\text{Fluid density, gm./cu.cm.}}$

$= \frac{\text{Centipoise}}{\text{Sp.Gr. of liquid relative to water at 39.2° F. (4° C.)}}$

Centistokes $\times 0.01 =$ stokes, sq.cm./sec.

Centistokes $\times 1.076 \times 10^{-5} =$ sq.ft./sec.

Centistokes $\times 0.01 =$ Stokes, sq.cm./sec.

Thermal Conductivity (through a homogeneous material)

$\frac{\text{Btu (ft.)}}{(\text{sq.ft.}) (\text{°F.}) (\text{hr.})} \times 4.134 \times 10^{-3} = \frac{(\text{g.-cal.}) (\text{cm.})}{(\text{sq.cm.}) (\text{°C.}) (\text{sec.})}$

$\times 1.200 \times 10 = \frac{(\text{Btu}) (\text{in.})}{(\text{sq.ft.}) (\text{°F.}) (\text{hr.})}$

$\times 3.518 \times 10^{-3} = \frac{(\text{kilowatt hrs.}) (\text{in.})}{(\text{sq.ft.}) (\text{°F.}) (\text{hr.})}$

$\frac{(\text{g.-cal.}) (\text{cm.})}{(\text{sq.cm.}) (\text{°C.}) (\text{hr.})} \times 8.063 \times 10^{-1} = \frac{\text{Btu (in.)}}{(\text{sq.ft.}) (\text{°F.}) (\text{hr.})}$

$\times 6.719 \times 10^{-2} = \frac{\text{Btu (ft.)}}{(\text{sq.ft.}) (\text{°F.}) (\text{hr.})}$

$\frac{(\text{g.-cal.}) (\text{cm.})}{(\text{sq.cm.}) (\text{°C.}) (\text{sec.})} \times 2.903 \times 10^3 = \frac{\text{Btu (in.)}}{(\text{sq.ft.}) (\text{°F.}) (\text{hr.})}$

$\times 8.063 \times 10^{-1} = \frac{\text{Btu (in.)}}{(\text{sq.ft.}) (\text{°F.}) (\text{sec.})}$

$\times 8.506 \times 10^2 = \frac{(\text{joules}) (\text{in.})}{(\text{sq.ft.}) (\text{°F.}) (\text{sec.})}$

Specific Gravity (Liquid)

$s = \frac{\rho \text{ of liquid @ } 60^\circ \text{ F.}^*}{\rho \text{ of water @ } 60^\circ \text{ F.}^*}$

* or at other specified temperature

Oil

$s \text{ at } 60^\circ \text{ F./}60^\circ \text{ F.} = \frac{141.5}{131.5 + \text{degrees API}}$

Liquids Lighter Than Water

$s \text{ @ } 60^\circ \text{ F./}60^\circ \text{ F.} = \frac{140}{130 + \text{degrees Baume}'}$

Liquids Heavier Than Water

$s \text{ @ } 60^\circ \text{ F./}60^\circ \text{ F.} = \frac{145}{145 - \text{degrees Baume}'}$

Specific Gravity (Gases)

$S_g = \frac{R \text{ of air}}{R \text{ of gas}} = \frac{53.3}{R \text{ of gas}}$, where R = gas constant

$S_g = \frac{\text{mol. wt. (gas)}}{\text{mol. wt. (air)}} = \frac{\text{mol. wt. (gas)}}{29}$

Density, Liquid ρ

Density liquid, $\rho = (62.3 \text{ lb./cu. ft. water}) (\text{Sp. Gr. liquid})$,
pounds /cu. ft.

Metric

1 gram = 10 decigrams
= 100 centigrams
= 1,000 milligrams
= 1,000,000 microgram
= 0.001 kilogram
= 10⁻⁶ megagram

1 liter = 10 deciliters = 1.0567 liquid quarts
10 liters = 1 dekaliter = 2.6417 liquid gallons
10 dekaliters = 1 hectoliter = 2.8375 U. S. bushels

D-2 Physical Property Conversion Factors

1 meter = 10 decimeters = 39.37 inches
 = 100 centimeters
 = 1,000 millimeters
 = 1,000,000 microns = 1,000,000 micrometers
 = 1/1,000 kilometer
 = 10^{10} Angstrom units

10 millimeters = 1 centimeter = 0.3937 inches
 10 centimeters = 1 decimeter = 3.937 inches
 25.4 millimeters = 1 inch

Specific Heat

$$\frac{(\text{gram-cal.})}{(\text{gram})(^{\circ}\text{C.})} \times 1.8 = \frac{\text{Btu}}{(\text{pound})(^{\circ}\text{C.})}$$

$$\times 1.0 = \frac{\text{Btu}}{(\text{pound})(^{\circ}\text{F.})}$$

$$\times 4.186 = \frac{\text{joules}}{(\text{gram})(^{\circ}\text{C.})}$$

$$\times 1055 = \frac{\text{joules}}{(\text{pound})(^{\circ}\text{F.})}$$

$$\times 1.163 \times 10^{-3} = \frac{\text{kilowatt-hours}}{(\text{kilogram})(^{\circ}\text{C.})}$$

$$\times 2.930 \times 10^{-4} = \frac{\text{kilowatt-hours}}{(\text{pound})(^{\circ}\text{F.})}$$

Specific heat of water at 1 atm. = 0.238 cal./gm-°C.
 Btu/lb. - ° F. \times 0.2390 = Btu/lb. - ° R

Heat Transfer Coefficient

$$\text{PCU}/(\text{hr.})(\text{sq. ft.})(^{\circ}\text{C.}) \times 1.0$$

$$= \text{Btu}/(\text{hr.})(\text{sq. ft.})(^{\circ}\text{F.})$$

$$\text{Kg-cal.}/(\text{hr.})(\text{sq. m.})(^{\circ}\text{C.}) \times 0.2048$$

$$= \text{Btu}/(\text{hr.})(\text{sq. ft.})(^{\circ}\text{F.})$$

$$\text{G-cal.}/(\text{sec.})(\text{sq. cm.})(^{\circ}\text{C.}) \times 7,380$$

$$= \text{Btu}/(\text{hr.})(\text{sq. ft.})(^{\circ}\text{F.})$$

$$\text{Watts}/(\text{sq. in.})(^{\circ}\text{F.}) \times 490 = \text{Btu}/(\text{hr.})(\text{sq. ft.})(^{\circ}\text{F.})$$

Energy Units

$$\text{Pound-Centigrade-Unit(PCU)} \times 1.8 = \text{Btu}$$

$$\times 0.45359 = \text{calorie}$$

$$\times 1400.4 = \text{ft.-lb.}$$

$$\times 0.0005276 = \text{kilowatt-hr.}$$

$$\times 1899.36 = \text{joules}$$

$$\text{Calories} \times 3.9683 = \text{Btu}$$

$$\times 3091.36 = \text{ft.-lb.}$$

$$\times 0.001559 = \text{horsepower-hr.}$$

$$\times 0.001163 = \text{kilowatt-hr.}$$

$$\times 4187.37 = \text{joules}$$

Pressure

$$1 \text{ mm Hg} = 1,333 \text{ dynes/sq. cm.}$$

$$750 \text{ mm Hg} = 10 \text{ dynes/sq. cm.} = 1 \text{ megabar @ } ^{\circ}\text{C.}$$

$$\text{and } g = 980.6$$

D-3
Synchronous Speeds

$$\text{Synchronous Speed} = \frac{\text{Frequency} \times 120}{\text{No. of Poles}}$$

| FREQUENCY | | | | FREQUENCY | | |
|-----------|----------|----------|----------|-----------|----------|----------|
| Poles | 60 cycle | 50 cycle | 25 cycle | Poles | 60 cycle | 50 cycle |
| 2 | 3600 | 3000 | 1500 | 42 | 171.4 | 142.9 |
| 4 | 1800 | 1500 | 750 | 44 | 163.6 | 136.4 |
| 6 | 1200 | 1000 | 500 | 46 | 156.5 | 130.4 |
| 8 | 900 | 750 | 375 | 48 | 150 | 125 |
| 10 | 720 | 600 | 300 | 50 | 144 | 120 |
| 12 | 600 | 500 | 250 | 52 | 138.5 | 115.4 |
| 14 | 514.3 | 428.6 | 214.3 | 54 | 133.3 | 111.1 |
| 16 | 450 | 375 | 187.5 | 56 | 128.6 | 107.1 |
| 18 | 400 | 333.3 | 166.7 | 58 | 124.1 | 103.5 |
| 20 | 360 | 300 | 150 | 60 | 120 | 100 |
| 22 | 327.2 | 272.7 | 136.4 | 62 | 116.1 | 96.8 |
| 24 | 300 | 250 | 125 | 64 | 112.5 | 93.7 |
| 26 | 276.9 | 230.8 | 115.4 | 66 | 109.1 | 90.9 |
| 28 | 257.1 | 214.3 | 107.1 | 68 | 105.9 | 88.2 |
| 30 | 240 | 200 | 100 | 70 | 102.9 | 85.7 |
| 32 | 225 | 187.5 | 93.7 | 72 | 100 | 83.3 |
| 34 | 211.8 | 176.5 | 88.2 | 74 | 97.3 | 81.1 |
| 36 | 200 | 166.7 | 83.3 | 76 | 94.7 | 78.9 |
| 38 | 189.5 | 157.9 | 78.9 | 78 | 92.3 | 76.9 |
| 40 | 180 | 150 | 75 | 80 | 90 | 75 |

Courtesy Ingersoll-Rand Co.

Conversion Factors

| Units of Length | Multiply units in left column by proper factor below | | | | | | | |
|-----------------|--|--------|--------|--------|-------|-------|--------|-------|
| | in. | ft. | yd. | mile | mm. | cm. | m. | km. |
| 1 inch | 1 | 0.0833 | 0.0278 | — | 25.40 | 2.540 | 0.0254 | — |
| 1 foot | 12 | 1 | 0.3333 | — | 304.8 | 30.48 | 0.3048 | — |
| 1 yard | 36 | 3 | 1 | — | 914.4 | 91.44 | 0.9144 | — |
| 1 mile | — | 5280 | 1760 | 1 | — | — | 1609.3 | 1.609 |
| 1 millimeter | 0.0394 | 0.0033 | — | — | 1 | 0.100 | 0.001 | — |
| 1 centimeter | 0.3937 | 0.0328 | 0.0109 | — | 10 | 1 | 0.01 | — |
| 1 meter | 39.37 | 3.281 | 1.094 | — | 1000 | 100 | 1 | 0.001 |
| 1 kilometer | — | 3281 | 1094 | 0.6214 | — | — | 1000 | 1 |

(1 micron = 0.001 millimeter)

Courtesy Ingersoll-Rand Co.

884 APPENDIX D

D-4 (Continued). Conversion Factors

| Units of Weight | Multiply units in left column by proper factor below | | | | | | |
|-----------------|--|--------|--------|--------|--------|--------|------------|
| | grain | oz. | lb. | ton | gram | kg. | metric ton |
| 1 grain | 1 | — | — | — | 0.0648 | — | — |
| 1 ounce | 437.5 | 1 | 0.0625 | — | 28.35 | 0.0283 | — |
| 1 pound | 7000 | 16 | 1 | 0.0005 | 453.6 | 0.4536 | — |
| 1 ton | — | 32,000 | 2000 | 1 | — | 907.2 | 0.9072 |
| 1 gram | 15.43 | 0.0353 | — | — | 1 | 0.001 | — |
| 1 kilogram | — | 35.27 | 2.205 | — | 1000 | 1 | 0.001 |
| 1 metric ton | — | 35,274 | 2205 | 1.1023 | — | 1000 | 1 |

| Units of Density | Multiply units in left column by proper factor below | | | | |
|------------------|--|------------|---------|-----------|---------|
| | lb/cu. in. | lb/cu. ft. | lb/gal. | g/cu. cm. | g/liter |
| 1 pound/cu. in. | 1 | 1728 | 231.0 | 27.68 | 27,680 |
| 1 pound/cu. ft. | — | 1 | 0.1337 | 0.0160 | 16.019 |
| 1 pound/gal. | 0.00433 | 7.481 | 1 | 0.1198 | 119.83 |
| 1 gram/cu. cm. | 0.0361 | 62.43 | 8.345 | 1 | 1000.0 |
| 1 gram/liter | — | 0.0624 | 0.00835 | 0.001 | 1 |

| Units of Area | Multiply units in left column by proper factor below | | | | | | |
|------------------|--|---------|-------|----------|---------|--------|---------|
| | sq. in. | sq. ft. | acre | sq. mile | sq. cm. | sq. m. | hectare |
| 1 sq. inch | 1 | 0.0069 | — | — | 6.452 | — | — |
| 1 sq. foot | 144 | 1 | — | — | 929.0 | 0.0929 | — |
| 1 acre | — | 43,560 | 1 | 0.0016 | — | 4047 | 0.4047 |
| 1 sq. mile | — | — | 640 | 1 | — | — | 259.0 |
| 1 sq. centimeter | 0.1550 | — | — | — | 1 | 0.0001 | — |
| 1 sq. meter | 1550 | 10.76 | — | — | 10,000 | 1 | — |
| 1 hectare | — | — | 2.471 | — | — | 10,000 | 1 |

| Units of Volume | Multiply units in left column by proper factor below | | | | | | | |
|-------------------|--|---------|---------|-----------|-----------|--------|-----------|-----------|
| | cu. in. | cu. ft. | cu. yd. | cu. cm. | cu. meter | liter | U.S. gal. | Imp. gal. |
| 1 cu. inch | 1 | — | — | 16.387 | — | 0.0164 | — | — |
| 1 cu. foot | 1728 | 1 | 0.0370 | 28,317 | 0.0283 | 28.32 | 7.481 | 6.229 |
| 1 cu. yard | 46,656 | 27 | 1 | — | 0.7646 | 764.5 | 202.0 | 168.2 |
| 1 cu. centimeter | 0.0610 | — | — | 1 | — | 0.0010 | — | — |
| 1 cu. meter | 61,023 | 35.31 | 1.308 | 1,000,000 | 1 | 999.97 | 264.2 | 220.0 |
| 1 liter | 61.025 | 0.0353 | — | 1000.028 | 0.0010 | 1 | 0.2642 | 0.2200 |
| 1 U.S. gallon | 231 | 0.1337 | — | 3785.4 | — | 3.785 | 1 | 0.8327 |
| 1 Imperial gallon | 277.4 | 0.1605 | — | 4546.1 | — | 4.546 | 1.201 | 1 |

D-4 (Continued). Conversion Factors

| Units of Pressure | Multiply units in left column by proper factor below | | | | | | |
|---|--|------------|-----------|--------------------|---------------|----------------|---------------------|
| | lb/sq. in. | lb/sq. ft. | int. atm. | kg/cm ² | mm Hg at 32°F | in. Hg at 32°F | ft. water at 39.2°F |
| 1 pound/sq. in. | 1 | 144 | — | 0.0703 | 51.713 | 2.0359 | 2.307 |
| 1 pound/sq. ft. | 0.00694 | 1 | — | — | 0.3591 | 0.01414 | 0.01602 |
| 1 intern. atmosphere | 14.696 | 2116.2 | 1 | 1.0333 | 760 | 29.921 | 33.90 |
| 1 kilogram/sq. cm. | 14.223 | 2048.1 | 0.9678 | 1 | 735.56 | 28.958 | 32.81 |
| 1 millimeter-mercury— 1 torr (torricelli)— | 0.0193 | 2.785 | — | — | 1 | 0.0394 | 0.0446 |
| 1 inch mercury | 0.4912 | 70.73 | 0.0334 | 0.0345 | 25.400 | 1 | 1.133 |
| 1 foot water | 0.4335 | 62.42 | — | 0.0305 | 22.418 | 0.8826 | 1 |

| Units of Energy | Multiply units in left column by proper factor below | | | | | |
|----------------------|--|----------|---------|--------|--------|--------|
| | ft.-lb. | Btu | g. cal. | Joule | kw-hr. | hp-hr. |
| 1 foot-pound | 1 | 0.001285 | 0.3240 | 1.3556 | — | — |
| 1 Btu | 778.2 | 1 | 252.16 | 1054.9 | — | — |
| 1 gram calorie | 3.0860 | 0.003966 | 1 | 4.1833 | — | — |
| 1 int. Joule | 0.7377 | 0.000948 | 0.2390 | 1 | — | — |
| 1 int. kilowatt-hour | 2,655,656 | 3412.8 | 860,563 | — | 1 | 1.3412 |
| 1 horsepower-hour | 1,980,000 | 2544.5 | 641,617 | — | 0.7456 | 1 |

| Units of Specific Energy | Multiply units in left column by proper factor below | | | | |
|--------------------------|--|--------------|---------|------------|---------|
| | absolute Joule/g | int. Joule/g | cal/g | int. cal/g | Btu/lb. |
| 1 absolute Joule/gram | 1 | 0.99984 | 0.23901 | 0.23885 | 0.42993 |
| 1 int. Joule/gram | 1.000165 | 1 | 0.23904 | 0.23892 | 0.43000 |
| 1 calorie/gram | 4.1840 | 4.1833 | 1 | 0.99935 | 1.7988 |
| 1 int. calorie/gram | 4.1867 | 4.1860 | 1.00065 | 1 | 1.8000 |
| 1 Btu/lb | 2.3260 | 2.3256 | 0.55592 | 0.55556 | 1 |

| Units of Power (rates of energy use) | Multiply units in left column by proper factor below | | | | | | | | |
|---|--|-------|--------|----------|---------|------------|------------|-------------|-----------|
| | hp | watt | kw | Btu/min. | Btu/hr. | ft-lb/sec. | ft-lb/min. | g. cal/sec. | metric hp |
| 1 horsepower | 1 | 745.7 | 0.7475 | 42.41 | 2544.5 | 550 | 33,000 | 178.2 | 1.014 |
| 1 watt | — | 1 | 0.001 | 0.0569 | 3.413 | 0.7376 | 44.25 | 0.2390 | 0.00136 |
| 1 kilowatt | 1.3410 | 1000 | 1 | 56.88 | 3412.8 | 737.6 | 44,254 | 239.0 | 1.360 |
| 1 Btu per minute | — | — | — | 1 | 60 | 12.97 | 778.2 | 4.203 | 0.0239 |
| 1 metric hp | 0.9863 | 735.5 | 0.7355 | 41.83 | 2509.6 | 542.5 | 32,550 | 175.7 | 1 |

| Units of Refrigeration | Multiply units in left column by factor below | | | | | |
|------------------------|---|-------------|------------|--------------------|---------------------|--------------|
| | Btu(IT)/min. | Btu(IT)/hr. | kg cal/hr. | ton (U.S.) comm | ton (BRIT.) comm | frigorie/hr. |
| 1 ton (U.S.) comm | 200 | 12,000 | 3025.9 | 1 | 0.8965 | 3025.9 |
| 1 ton (Brit) comm | 223.08 | 13,385 | 3375.2 | 1.1154 | 1 | 3375.2 |
| 1 frigorie/hr. | 0.06609 | 3.9657 | 1 | 0.0003305 | 0.0002963 | 1 |

Note:—Btu is International Steam Table Btu(IT). 1 frigorie = 1 kg cal (Not IT).

886 APPENDIX D

D-5 Temperature Conversion

NOTE: The center column of numbers in boldface refers to the temperature in degrees, either Centigrade or Fahrenheit, which it is desired to convert into the other scale. If converting from Fahrenheit to Centigrade degrees, the equivalent temperature will be found in the left column; while if converting from degrees Centigrade to degrees Fahrenheit, the answer will be found in the column on the right.

Table with 8 columns: Centigrade, Fahrenheit, Centigrade, Fahrenheit, Centigrade, Fahrenheit, Centigrade, Fahrenheit. It provides conversion values for a wide range of temperatures, with boldface numbers in the center columns.

The formulas at the right may also be used for converting Centigrade or Fahrenheit degrees into the other scales.

Degrees Cent., °C = 5/9 (°F + 40) - 40

Degrees Fahr., °F = 9/5 (°C + 40) - 40

= 5/9 (°F - 32)

= 9/5 C + 32

Degrees Kelvin, °K = °C + 273.2

Degrees Rankine, °R = °F + 459.7

D-6
Altitude and Atmospheric Pressures

| Altitude above Sea Level | | | Temperature** | | Barometer* | | Atmospheric Pressure | |
|--------------------------|-------|---------|---------------|-----|----------------------|---------------------|----------------------|---------------|
| Feet* | Miles | Meters* | °F | °C | Inches Hg Abs. | mm Hg Abs. | PSIA | Kg/sq cm Abs. |
| -5000 | — | -1526 | 77 | 25 | 35.58 | 903.7 | 17.48 | 1.229 |
| -4500 | — | -1373 | 75 | 24 | 35.00 | 889.0 | 17.19 | 1.209 |
| -4000 | — | -1220 | 73 | 23 | 34.42 | 874.3 | 16.90 | 1.188 |
| -3500 | — | -1068 | 71 | 22 | 33.84 | 859.5 | 16.62 | 1.169 |
| -3000 | — | -915 | 70 | 21 | 33.27 | 845.1 | 16.34 | 1.149 |
| -2500 | — | -763 | 68 | 20 | 32.70 | 830.6 | 16.06 | 1.129 |
| -2000 | — | -610 | 66 | 19 | 32.14 | 816.4 | 15.78 | 1.109 |
| -1500 | — | -458 | 64 | 18 | 31.58 | 802.1 | 15.51 | 1.091 |
| -1000 | — | -305 | 63 | 17 | 31.02 | 787.9 | 15.23 | 1.071 |
| -500 | — | -153 | 61 | 16 | 30.47 | 773.9 | 14.96 | 1.052 |
| 0 | — | 0 | 59 | 15 | 29.92 | 760.0 | 14.696 | 1.0333 |
| 500 | — | 153 | 57 | 14 | 29.38 | 746.3 | 14.43 | 1.015 |
| 1000 | — | 305 | 55 | 13 | 28.86 | 733.0 | 14.16 | .956 |
| 1500 | — | 458 | 54 | 12 | 28.33 | 719.6 | 13.91 | .978 |
| 2000 | — | 610 | 52 | 11 | 27.82 | 706.6 | 13.66 | .960 |
| 2500 | — | 763 | 50 | 10 | 27.32 | 693.9 | 13.41 | .943 |
| 3000 | — | 915 | 48 | 9 | 26.82 | 681.2 | 13.17 | .926 |
| 3500 | — | 1068 | 47 | 8 | 26.33 | 668.8 | 12.93 | .909 |
| 4000 | — | 1220 | 45 | 7 | 25.84 | 656.3 | 12.69 | .892 |
| 4500 | — | 1373 | 43 | 6 | 25.37 | 644.4 | 12.46 | .876 |
| 5000 | 0.95 | 1526 | 41 | 5 | 24.90 | 632.5 | 12.23 | .860 |
| 6000 | 1.1 | 1831 | 38 | 3 | 23.99 | 609.3 | 11.78 | .828 |
| 7000 | 1.3 | 2136 | 34 | 1 | 23.10 | 586.7 | 11.34 | .797 |
| 8000 | 1.5 | 2441 | 31 | -1 | 22.23 | 564.6 | 10.91 | .767 |
| 9000 | 1.7 | 2746 | 27 | -3 | 21.39 | 543.3 | 10.50 | .738 |
| 10,000 | 1.9 | 3050 | 23 | -5 | 20.58 | 522.7 | 10.10 | .710 |
| 15,000 | 2.8 | 4577 | 6 | -14 | 16.89 | 429.0 | 8.29 | .583 |
| 20,000 | 3.8 | 6102 | -12 | -24 | 13.76 | 349.5 | 6.76 | .475 |
| 25,000 | 4.7 | 7628 | -30 | -34 | 11.12 | 282.4 | 5.46 | .384 |
| 30,000 | 5.7 | 9153 | -48 | -44 | 8.903 | 226.1 | 4.37 | .307 |
| 35,000 | 6.6 | 10,679 | -66 | — | 7.060 | 179.3 | 3.47 | .244 |
| 40,000 | 7.6 | 12,204 | -70 | -57 | 5.558 | 141.2 | 2.73 | .192 |
| 45,000 | 8.5 | 13,730 | -70 | -57 | 4.375 | 111.1 | 2.15 | .151 |
| 50,000 | 9.5 | 15,255 | -70 | -57 | 3.444 | 87.5 | 1.69 | .119 |
| 55,000 | 10.4 | 16,781 | -70 | -57 | 2.712 | 68.9 | 1.33 | .0935 |
| 60,000 | 11.4 | 18,306 | -70 | -57 | 2.135 | 54.2 | 1.05 | .0738 |
| 70,000 | 13.3 | 21,357 | -67 | -55 | 1.325 | 33.7 | .651 | .0458 |
| 80,000 | 15.2 | 24,408 | -62 | -52 | †8.273 ⁻¹ | 21.0 | .406 | .0285 |
| 90,000 | 17.1 | 27,459 | -57 | -59 | 5.200 ⁻¹ | 13.2 | .255 | .0179 |
| 100,000 | 18.9 | 30,510 | -51 | -46 | 3.290 ⁻¹ | 8.36 | .162 | .0114 |
| 120,000 | 22.8 | 36,612 | -26 | -48 | 1.358 ⁻¹ | 3.45 | — | — |
| 140,000 | 26.6 | 42,714 | 4 | -16 | 5.947 ⁻² | 1.51 | — | — |
| 160,000 | 30.4 | 48,816 | 28 | -2 | 2.746 ⁻² | †6.97 ⁻¹ | — | — |
| 180,000 | 34.2 | 54,918 | 19 | -7 | 1.284 ⁻² | 3.26 ⁻¹ | — | — |
| 200,000 | 37.9 | 61,020 | -3 | -19 | 5.846 ⁻³ | 1.48 ⁻¹ | — | — |
| 220,000 | 41.7 | 67,122 | -44 | -42 | 2.523 ⁻³ | 6.41 ⁻² | — | — |
| 240,000 | 45.5 | 73,224 | -86 | -66 | 9.955 ⁻⁴ | 2.53 ⁻² | — | — |
| 260,000 | 49.3 | 79,326 | -129 | -90 | 3.513 ⁻⁴ | 8.92 ⁻³ | — | — |
| 280,000 | 53.1 | 85,428 | -135 | -93 | 1.143 ⁻⁴ | 3.67 ⁻³ | — | — |
| 300,000 | 56.9 | 91,530 | -127 | -88 | 3.737 ⁻⁵ | 9.49 ⁻⁴ | — | — |
| 400,000 | 75.9 | 122,040 | — | — | 6.3 ⁻⁷ | 1.60 ⁻⁵ | — | — |
| 500,000 | 94.8 | 152,550 | — | — | 1.4 ⁻⁷ | 3.56 ⁻⁶ | — | — |
| 600,000 | 114 | 183,060 | — | — | 5.9 ⁻⁸ | 1.50 ⁻⁶ | — | — |
| 800,000 | 152 | 244,080 | — | — | 1.6 ⁻⁸ | 4.06 ⁻⁷ | — | — |
| 1,000,000 | 189 | 305,100 | — | — | 5.1 ⁻⁹ | 1.30 ⁻⁷ | — | — |
| 1,200,000 | 228 | 366,120 | — | — | 2.0 ⁻⁹ | 5.08 ⁻⁸ | — | — |
| 1,400,000 | 266 | 427,140 | — | — | 8.2 ⁻¹⁰ | 2.08 ⁻⁸ | — | — |
| 1,600,000 | 304 | 488,160 | — | — | 3.8 ⁻¹⁰ | 9.65 ⁻⁹ | — | — |
| 1,800,000 | 342 | 549,180 | — | — | 1.8 ⁻¹⁰ | 4.57 ⁻⁹ | — | — |
| 2,000,000 | 379 | 610,200 | — | — | 9.2 ⁻¹¹ | 2.34 ⁻⁹ | — | — |

Data from NASA Standard Atmosphere (1962).
 *Temperature and barometer are approximate for negative altitudes.
 **Temperatures are average existing at 40° latitude and are rounded to even numbers.
 †Negative exponent shows number of spaces the decimal point must be moved to the left.
 Courtesy Ingersoll-Rand Co.

D-7
Vapor Pressure Curves. (Courtesy Ingersoll-Rand Co.)

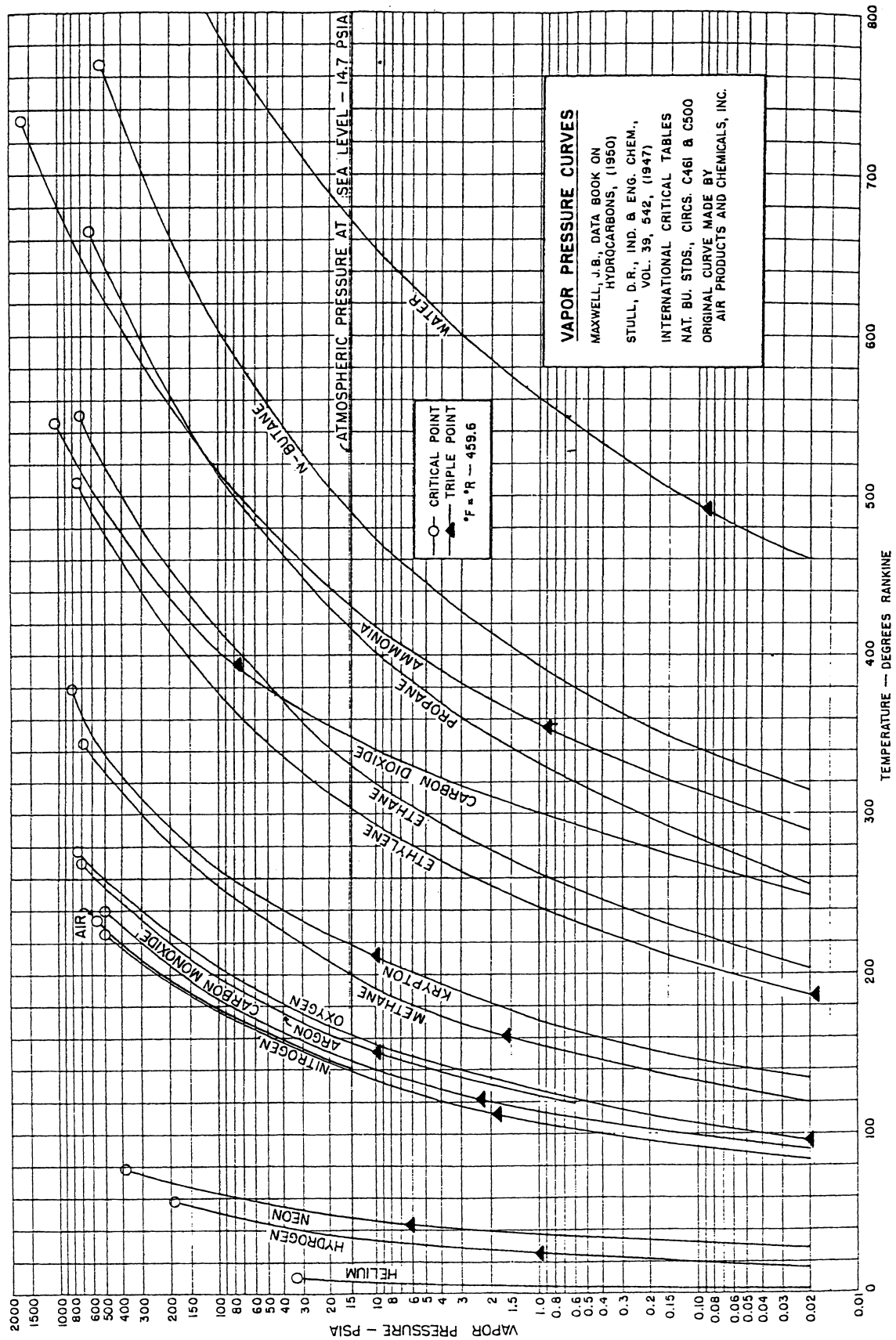

D-8
Pressure Conversion Chart

BY FACTOR TO OBTAIN →

| GIVEN | lb/in ² | in H ₂ O (at +39.2°F) | cm H ₂ O (at +4°C) | in Hg (at +32°F) | mm Hg (Torr) (at 0°C) | dyna/cm ² (1 μ bar) | newton/m ² (PASCAL) | kgm/cm ² | bar | atm. (A _n) | lb/ft ² | ft H ₂ O (at +39.2°F) |
|-------------------------------------|-------------------------|-------------------------------------|----------------------------------|-------------------------|--------------------------|-----------------------------------|-----------------------------------|-------------------------|-------------------------|-------------------------|-------------------------|-------------------------------------|
| lb/in ² | 1.0000 | 2.7680x10 ¹ | 7.0308x10 ¹ | 2.0360 | 5.1715x10 ¹ | 8.8948x10 ¹ | 8.8948x10 ³ | 7.0308x10 ⁻² | 6.8947x10 ⁻² | 6.8045x10 ⁻² | 1.4400x10 ² | 2.3067 |
| in H ₂ O (at +39.2°F) | 3.6127x10 ⁻² | 1.0000 | 2.5400 | 7.3554x10 ⁻² | 1.8683 | 2.4908x10 ² | 2.4908x10 ³ | 2.5399x10 ⁻³ | 2.4908x10 ⁻³ | 2.4582x10 ⁻³ | 5.2022 | 8.3333x10 |
| cm H ₂ O (at +4°C) | 1.4223x10 ⁻² | 0.3937 | 1.0000 | 2.8958x10 ⁻² | 0.7355 | 9.8064x10 ² | 9.8064x10 ³ | 9.9997x10 ⁻⁴ | 9.8064x10 ⁻⁴ | 9.6781x10 ⁻⁴ | 2.0481 | 3.2808x10 ⁻² |
| in Hg (at +32°F) | 4.8116x10 ⁻¹ | 1.3596x10 ¹ | 3.4532x10 ¹ | 1.0000 | 2.5400x10 ¹ | 3.3864x10 ⁴ | 3.3864x10 ⁵ | 3.4532x10 ⁻² | 3.3864x10 ⁻² | 3.3421x10 ⁻² | 7.0727x10 ¹ | 1.1330 |
| mm Hg (Torr) (at 0°C) | 1.9337x10 ⁻¹ | 5.3525x10 ⁻¹ | 1.3695 | 3.9370x10 ⁻² | 1.0000 | 1.3332x10 ⁵ | 1.3332x10 ⁶ | 1.3595x10 ⁻³ | 1.3332x10 ⁻³ | 1.3158x10 ⁻³ | 2.7845 | 4.4805x10 ⁻² |
| dyna/cm ² (1 μ bar) | 1.4504x10 ⁻⁵ | 4.0147x10 ⁻⁴ | 1.0197x10 ⁻³ | 2.8530x10 ⁻⁶ | 7.5006x10 ⁻⁴ | 1.0000 | 1.0000x10 ⁻¹ | 1.0197x10 ⁻⁶ | 1.0000x10 ⁻⁶ | 9.8692x10 ⁻⁷ | 2.0886x10 ⁻³ | 3.3456x10 ⁻⁶ |
| newton/m ² (PASCAL) | 1.4504x10 ⁻¹ | 4.0147x10 ⁻³ | 1.0197x10 ⁻² | 2.8530x10 ⁻⁴ | 7.5006x10 ⁻³ | 1.0000x10 ¹ | 1.0000 | 1.0197x10 ⁻⁵ | 1.0000x10 ⁻⁵ | 9.8692x10 ⁻⁶ | 2.0886x10 ⁻² | 3.3456x10 ⁻⁴ |
| kgm/cm ² | 1.4224x10 ¹ | 3.9371x10 ¹ | 1.00003x10 ³ | 2.8959x10 ¹ | 7.3556x10 ³ | 9.8060x10 ⁶ | 9.8060x10 ⁷ | 1.0000 | 9.8060x10 ⁻¹ | 9.878x10 ⁻¹ | 2.0482x10 ³ | 3.2809x10 ¹ |
| bar | 1.4504x10 ¹ | 4.0147x10 ² | 1.0197x10 ³ | 2.9530x10 ¹ | 7.5008x10 ³ | 1.0000x10 ⁶ | 1.0000x10 ⁸ | 1.0197 | 1.0000 | 9.8692x10 ⁻¹ | 2.0885x10 ³ | 3.3456x10 ¹ |
| atm. (A _n) | 1.4696x10 ¹ | 4.0679x10 ² | 1.0333x10 ³ | 2.9921x10 ¹ | 7.6000x10 ³ | 1.0133x10 ⁶ | 1.0133x10 ⁸ | 1.0332 | 1.0133 | 1.0000 | 2.1182x10 ³ | 3.3900x10 ¹ |
| lb/ft ² | 6.8445x10 ⁻³ | 1.9223x10 ⁻¹ | 4.882x10 ⁻¹ | 1.4139x10 ⁻² | 3.591x10 ⁻¹ | 4.7880x10 ² | 4.7880x10 ³ | 4.8824x10 ⁻⁴ | 4.7880x10 ⁻⁴ | 4.7254x10 ⁻⁴ | 1.0000 | 1.6019x10 ⁻² |
| ft H ₂ O (at +39.2°F) | 4.3362x10 ⁻¹ | 1.2000x10 ¹ | 3.0480x10 ¹ | 6.826x10 ⁻¹ | 2.2419x10 ¹ | 2.9890x10 ⁴ | 2.9890x10 ⁵ | 3.0479x10 ⁻³ | 2.9890x10 ⁻³ | 2.9499x10 ⁻³ | 6.2427x10 ¹ | 1.0000 |

← **MULTIPLY GIVEN NUMBER OF**

890 APPENDIX D

D-9 Vacuum Conversion

| Torr | Absolute Pressure | | Inches Hg (Abs.) | Psia | Vacuum* Inches Hg |
|--------------------|-------------------|-------|---------------------|--------|----------------------|
| | Microns Hg | Mm Hg | | | |
| | | 762 | 30.00 | 14.74 | — |
| | | 750 | 29.53 | 14.50 | 0.47 |
| | | 700 | 27.56 | 13.54 | 2.44 |
| | | 650 | 25.59 | 12.57 | 4.41 |
| | | 600 | 23.62 | 11.60 | 6.38 |
| | | 550 | 21.65 | 10.64 | 8.35 |
| | | 500 | 19.68 | 9.67 | 10.32 |
| | | 450 | 17.72 | 8.70 | 12.28 |
| | | 400 | 15.75 | 7.74 | 14.25 |
| | | 350 | 13.78 | 6.77 | 16.22 |
| | | 300 | 11.81 | 5.80 | 18.19 |
| | | 250 | 9.84 | 4.84 | 20.16 |
| | | 200 | 7.84 | 3.87 | 22.13 |
| | | 150 | 5.91 | 2.900 | 24.09 |
| | | 100 | 3.94 | 1.934 | 26.06 |
| | | 50 | 1.97 | 0.967 | 28.03 |
| | | 40 | 1.57 | 0.774 | 28.43 |
| | | 30 | 1.181 | 0.580 | 28.82 |
| | | 20 | 0.787 | 0.3868 | |
| | | 10 | 0.394 | 0.1934 | |
| | | 5 | 0.197 | 0.0967 | |
| | | 4 | 0.158 | 0.0774 | |
| | | 3 | 0.1181 | 0.0580 | |
| | | 2 | 0.0787 | 0.0387 | |
| 1.0 | 1000 | 1 | 0.0392 | 0.0193 | |
| 0.5 | 500 | 0.50 | 0.0197 | | Low Vacuum |
| 1×10^{-1} | 100 | 0.10 | 0.0039 | | |
| 5×10^{-2} | 50 | 0.050 | | | |
| 1×10^{-2} | 10 | 0.010 | | | |
| 5×10^{-3} | 5 | 0.005 | | | |
| 1×10^{-3} | 1 | 0.001 | | | |
| 1×10^{-4} | | | | | High Vacuum |
| 1×10^{-5} | to | | | | |
| 1×10^{-6} | | | | | Very High Vac. |
| 1×10^{-9} | to | | | | |
| 1×10^{-9} | | | | | Ultra High Vac. |
| and beyond | | | | | |

*Refers to 30" Barometer

Conversion Factors:

1 millimeter = 1000 microns

1 inch Hg = 25.4 mm Hg

1 Torr = 1 mm Hg Abs.

1 atmosphere = 14.7 pounds per sq. in. = 760 mm Hg = 29.92 in. Hg

Courtesy Pfaudler Co., Div. of Sybron Corp.

D-10
Decimal and Millimeter Equivalent of Fractions

| Inches | | MILLIMETERS | Inches | | MILLIMETERS |
|-----------|----------|-------------|-----------|----------|-------------|
| Fractions | Decimals | | Fractions | Decimals | |
| 1/64 | .015625 | 0.397 | 33/64 | .515625 | 13.097 |
| 1/32 | .03125 | 0.794 | 17/32 | .53125 | 13.494 |
| 3/64 | .046875 | 1.191 | 35/64 | .546875 | 13.891 |
| 1/16 | .0625 | 1.588 | 7/16 | .5625 | 14.288 |
| 5/64 | .078125 | 1.984 | 37/64 | .578125 | 14.684 |
| 3/32 | .09375 | 2.381 | 19/32 | .59375 | 15.081 |
| 7/64 | .109375 | 2.778 | 39/64 | .609375 | 15.478 |
| 1/8 | .125 | 3.175 | 3/8 | .625 | 15.875 |
| 9/64 | .140625 | 3.572 | 41/64 | .640625 | 16.272 |
| 5/32 | .15625 | 3.969 | 21/32 | .65625 | 16.669 |
| 11/64 | .171875 | 4.366 | 43/64 | .671875 | 17.066 |
| 3/16 | .1875 | 4.763 | 11/16 | .6875 | 17.463 |
| 13/64 | .203125 | 5.159 | 45/64 | .703125 | 17.859 |
| 7/32 | .21875 | 5.556 | 23/32 | .71875 | 18.256 |
| 15/64 | .234375 | 5.953 | 47/64 | .734375 | 18.653 |
| 1/4 | .25 | 6.350 | 3/4 | .75 | 19.050 |
| 17/64 | .265625 | 6.747 | 49/64 | .765625 | 19.447 |
| 9/32 | .28125 | 7.144 | 25/32 | .78125 | 19.844 |
| 19/64 | .296875 | 7.541 | 51/64 | .796875 | 20.241 |
| 5/16 | .3125 | 7.938 | 13/16 | .8125 | 20.638 |
| 21/64 | .328125 | 8.334 | 53/64 | .828125 | 21.034 |
| 11/32 | .34375 | 8.731 | 27/32 | .84375 | 21.431 |
| 23/64 | .359375 | 9.128 | 55/64 | .859375 | 21.828 |
| 3/8 | .375 | 9.525 | 7/8 | .875 | 22.225 |
| 25/64 | .390625 | 9.922 | 57/64 | .890625 | 22.622 |
| 13/32 | .40625 | 10.319 | 29/32 | .90625 | 23.019 |
| 27/64 | .421875 | 10.716 | 59/64 | .921875 | 23.416 |
| 7/16 | .4375 | 11.113 | 15/16 | .9375 | 23.813 |
| 29/64 | .453125 | 11.509 | 61/64 | .953125 | 24.209 |
| 15/32 | .46875 | 11.906 | 31/32 | .96875 | 24.606 |
| 31/64 | .484375 | 12.303 | 63/64 | .984375 | 25.003 |
| 1/2 | .500 | 12.700 | 1.000 | 25.400 | |

D-11
Particle Size Measurement

| Meshes/Lineal Inch US and ASTM Std. Sieve No. | Actual Opening | | Meshes/Lineal Inch US and ASTM Std. Sieve No. | Actual Opening | |
|---|----------------|---------|---|----------------|---------|
| | Inches | Microns | | Inches | Microns |
| 10 | .0787 | 2000 | 170 | .0035 | 88 |
| 12 | .0661 1/6 | 1680 | 200 | .0029 | 74 |
| 14 | .0555 | 1410 | | .0026 | 65 |
| 16 | .0469 3/64 | 1190 | 230 | .0024 | 62 |
| 18 | .0394 | 1000 | 270 | .0021 | 53 |
| 20 | .0331 1/32 | 840 | | .0020 | 50 |
| 25 | .0280 | 710 | 325 | .0017 | 44 |
| 30 | .0232 | 590 | | .0016 | 40 |
| 35 | .0197 1/64 | 500 | 400 | .00142 | 36 |
| 40 | .0165 | 420 | | .00118 | 30 |
| 45 | .0138 | 350 | 550 | .00099 | 25 |
| 50 | .0117 | 297 | 625 | .00079 | 20 |
| 60 | .0098 | 250 | | .00059 | 15 |
| 70 | .0083 | 210 | 1,250 | .000394 | 10 |
| 80 | .0070 | 177 | 1,750 | .000315 | 8 |
| 100 | .0059 | 149 | 2,500 | .000197 | 5 |
| 120 | .0049 | 125 | 5,000 | .000099 | 2.5 |
| 140 | .0041 | 105 | 12,000 | .0000394 | 1 |

* 1 micron (μ) = 1 micrometer (μm), new National Bureau of Standards terminology
 1 micron = one-millionth of a meter
 Inches X 25,400 = microns or micrometers
 Reference ASTM E 11-70

D-12
Viscosity Conversions. (By permission, Tube Turns Div., Chemetron Corp., Bull. TT 725.)

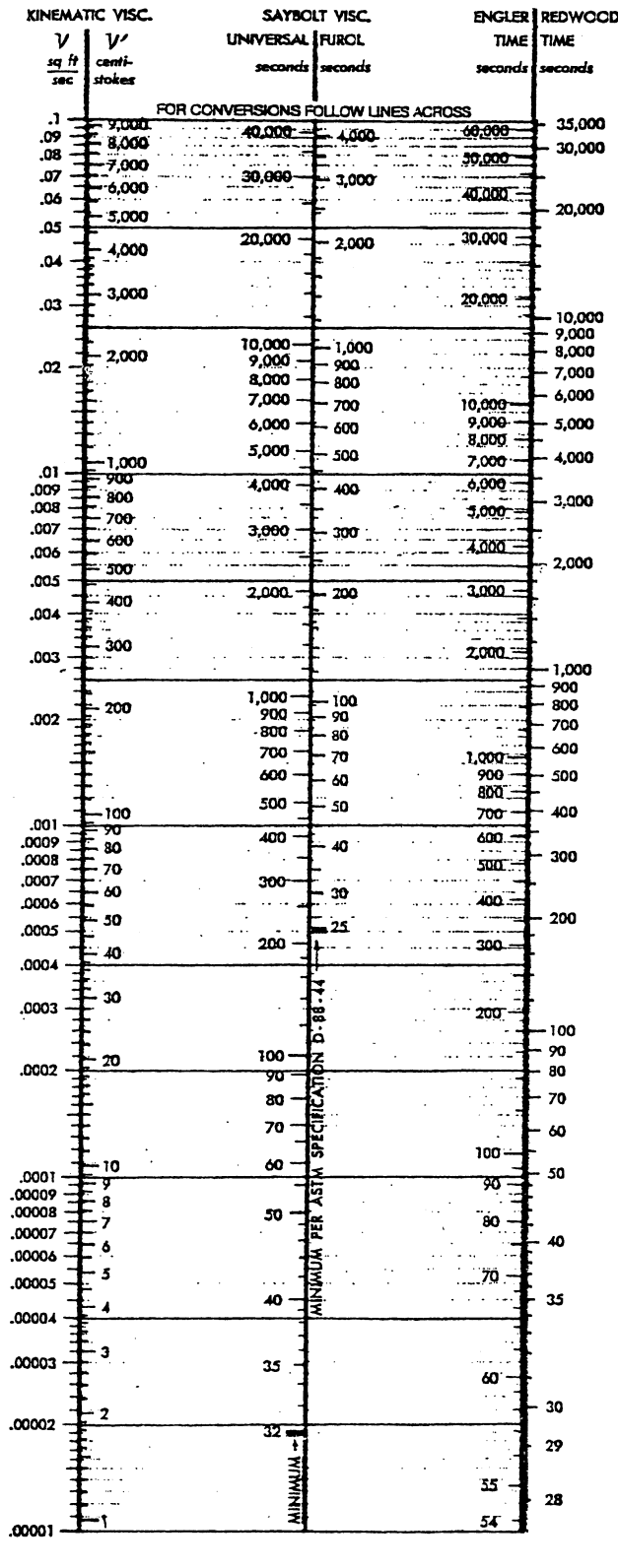

| | | |
|--|---|---|
| <p style="text-align: center;">To convert:</p> <ul style="list-style-type: none"> from Metric units (centistokes) from English units (sq ft per sec) from Saybolt Universal (seconds) from Saybolt Furol (seconds) from Engler (seconds) from Redwood standard (seconds) from absolute viscosity | <p style="text-align: center;">into centistokes (v')</p> <p>v' = 82.800 v see Table I in ASTM Spec. D-446-39 (plotted for basic temperature 100 F) see Table I in ASTM Spec. D-688-44 (plotted for std temp of 122 F) v' = 0.147 Engler - $\frac{374}{\text{Engler}}$ v' = 0.280 Redwood - $\frac{171.5}{\text{Redwood}}$ v' = $\frac{\text{centipoises}}{\text{density}}$</p> | <p style="text-align: center;">into sq ft per sec (v)</p> <p>v = 0.000 010 76 v' converted from ASTM Spec. D-446-39 converted from ASTM Spec. D-688-44 v = 0.000 001 88 Engler - $\frac{0.00403}{\text{Engler}}$ v = 0.000 002 80 Redwood - $\frac{0.00188}{\text{Redwood}}$ v = 32.2 $\frac{\mu}{\rho}$ (lb sec per sq ft) / (lb per cu ft)</p> |
|--|---|---|

To convert other units in- to kinematic viscosity in English units v (sq ft per sec) or in Metric units v' (centistokes), use the chart or the formulas to the right:

To convert degrees API and Baumé into Specific Gravity, use the formulas to right:

| | |
|--|--|
| <p style="text-align: center;">Liquids lighter than water (API Formula)</p> <p style="text-align: center;">Specific gravity 60/60F = $\frac{141.5}{131.5 + \text{Degrees API}}$</p> | <p style="text-align: center;">Liquids heavier than water (U.S. Bureau of Stds.)</p> <p style="text-align: center;">Specific gravity = $\frac{145}{148 - \text{Degrees Baumé}}$</p> |
|--|--|

D-13
Viscosity Conversions. (Courtesy Kinney Vacuum Div., The New York Air Brake Co.)

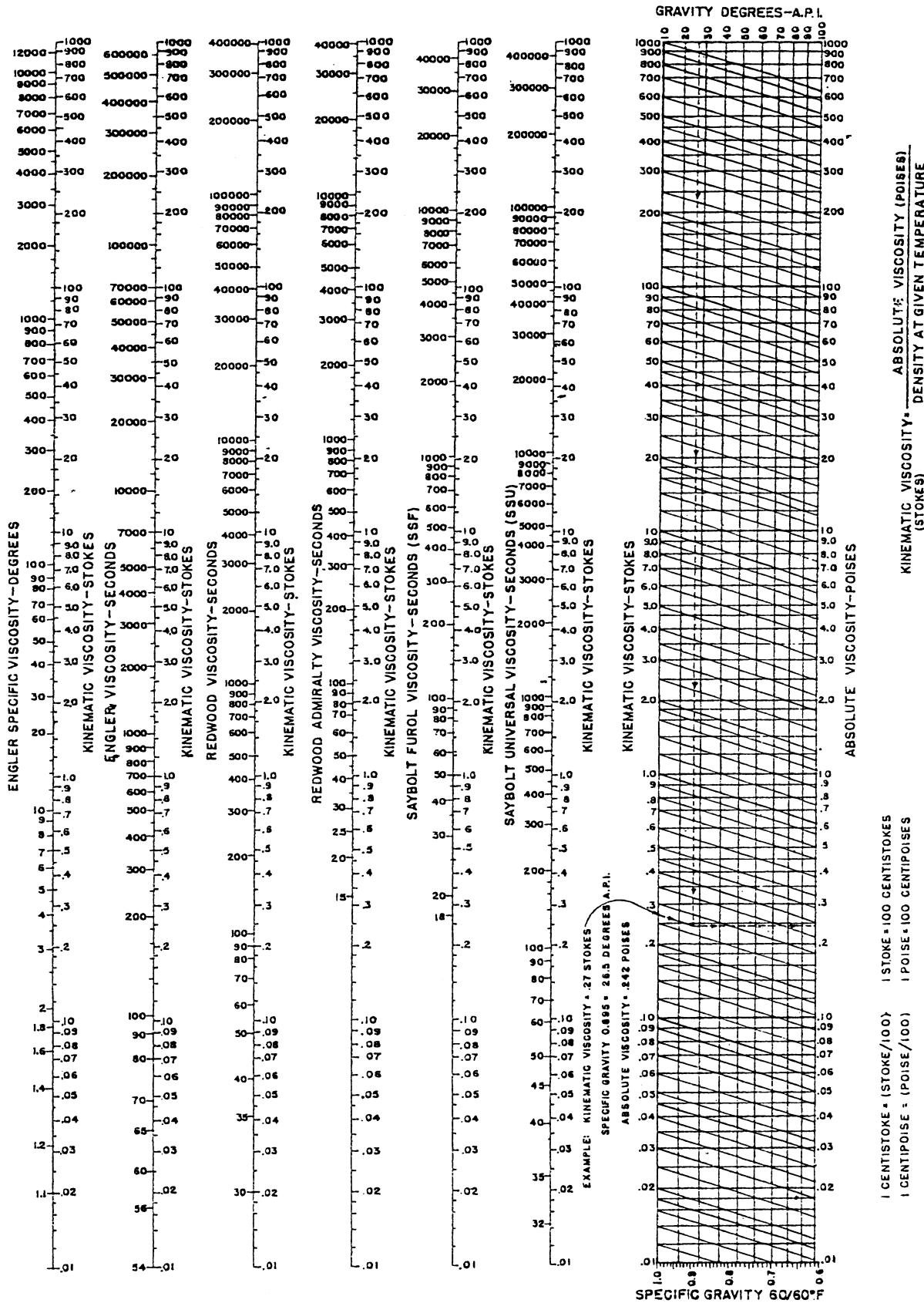

D-14
Commercial Wrought Steel Pipe Data
(Based on ANSI B36.10 wall thicknesses)

| | Nominal Pipe Size | Outside Diameter | Thick-ness | Inside Diameter | | Inside Diameter Functions (In Inches) | | | | Transverse Internal Area | |
|-------------|-------------------|------------------|------------|-----------------|----------|---------------------------------------|-----------------------|-----------------------|-----------------------|--------------------------|----------|
| | | | | <i>d</i> | <i>D</i> | <i>d</i> ² | <i>d</i> ³ | <i>d</i> ⁴ | <i>d</i> ⁵ | <i>a</i> | <i>A</i> |
| | Inches | Inches | Inches | Inches | Feet | | | | | Sq. In. | Sq. Ft. |
| Schedule 10 | | | | | | | | | | | |
| | 14 | 14 | 0.250 | 13.5 | 1.125 | 182.25 | 2460.4 | 33215. | 448400. | 143.14 | 0.994 |
| | 16 | 16 | 0.250 | 15.5 | 1.291 | 240.25 | 3723.9 | 57720. | 894660. | 188.69 | 1.310 |
| | 18 | 18 | 0.250 | 17.5 | 1.4583 | 306.25 | 5359.4 | 93789. | 1641309. | 240.53 | 1.670 |
| | 20 | 20 | 0.250 | 19.5 | 1.625 | 380.25 | 7414.9 | 144590. | 2819500. | 298.65 | 2.074 |
| | 24 | 24 | 0.250 | 23.5 | 1.958 | 552.25 | 12977. | 304980. | 7167030. | 433.74 | 3.012 |
| | 30 | 30 | 0.312 | 29.376 | 2.448 | 862.95 | 25350. | 744288. | 21864218. | 677.76 | 4.707 |
| Schedule 20 | | | | | | | | | | | |
| | 8 | 8.625 | 0.250 | 8.125 | 0.6771 | 66.02 | 536.38 | 4359.3 | 35409. | 51.85 | 0.3601 |
| | 10 | 10.75 | 0.250 | 10.25 | 0.8542 | 105.06 | 1076.9 | 11038. | 113141. | 82.52 | 0.5731 |
| | 12 | 12.75 | 0.250 | 12.25 | 1.021 | 150.06 | 1838.3 | 22518. | 275855. | 117.86 | 0.8185 |
| | 14 | 14 | 0.312 | 13.376 | 1.111 | 178.92 | 2393.2 | 32012. | 428185. | 140.52 | 0.9758 |
| | 16 | 16 | 0.312 | 15.376 | 1.281 | 236.42 | 3635.2 | 55894. | 859442. | 185.69 | 1.290 |
| | 18 | 18 | 0.312 | 17.376 | 1.448 | 301.92 | 5246.3 | 91156. | 1583978. | 237.13 | 1.647 |
| | 20 | 20 | 0.375 | 19.250 | 1.604 | 370.56 | 7133.3 | 137317. | 2643352. | 291.04 | 2.021 |
| | 24 | 24 | 0.375 | 23.25 | 1.937 | 540.56 | 12568. | 292205. | 6793832. | 424.56 | 2.948 |
| | 30 | 30 | 0.500 | 29.00 | 2.417 | 841.0 | 24389. | 707281. | 20511149. | 660.52 | 4.587 |
| Schedule 30 | | | | | | | | | | | |
| | 8 | 8.625 | 0.277 | 8.071 | 0.6726 | 65.14 | 525.75 | 4243.2 | 34248. | 51.16 | 0.3553 |
| | 10 | 10.75 | 0.307 | 10.136 | 0.8447 | 102.74 | 1041.4 | 10555. | 106987. | 80.69 | 0.5603 |
| | 12 | 12.75 | 0.330 | 12.09 | 1.0075 | 146.17 | 1767.2 | 21366. | 258304. | 114.80 | 0.7972 |
| | 14 | 14 | 0.375 | 13.25 | 1.1042 | 175.56 | 2326.2 | 30821. | 408394. | 137.88 | 0.9575 |
| | 16 | 16 | 0.375 | 15.25 | 1.2708 | 232.56 | 3546.6 | 54084. | 824801. | 182.65 | 1.268 |
| | 18 | 18 | 0.438 | 17.124 | 1.4270 | 293.23 | 5021.3 | 85984. | 1472397. | 230.30 | 1.599 |
| | 20 | 20 | 0.500 | 19.00 | 1.5833 | 361.00 | 6859.0 | 130321. | 2476099. | 283.53 | 1.969 |
| | 24 | 24 | 0.562 | 22.876 | 1.9063 | 523.31 | 11971. | 273853. | 6264703. | 411.00 | 2.854 |
| | 30 | 30 | 0.625 | 28.75 | 2.3958 | 826.56 | 23764. | 683201. | 19642160. | 649.18 | 4.508 |
| Schedule 40 | | | | | | | | | | | |
| | 1/8 | 0.405 | 0.068 | 0.269 | 0.0224 | 0.0724 | 0.0195 | 0.005242 | 0.00141 | 0.057 | 0.00040 |
| | 1/4 | 0.540 | 0.088 | 0.364 | 0.0303 | 0.1325 | 0.0482 | 0.01756 | 0.00639 | 0.104 | 0.00072 |
| | 3/8 | 0.675 | 0.091 | 0.493 | 0.0411 | 0.2430 | 0.1198 | 0.05905 | 0.02912 | 0.191 | 0.00133 |
| | 1/2 | 0.840 | 0.109 | 0.622 | 0.0518 | 0.3869 | 0.2406 | 0.1497 | 0.09310 | 0.304 | 0.00211 |
| | 3/4 | 1.050 | 0.113 | 0.824 | 0.0687 | 0.679 | 0.5595 | 0.4610 | 0.3799 | 0.533 | 0.00371 |
| | 1 | 1.315 | 0.133 | 1.049 | 0.0874 | 1.100 | 1.154 | 1.210 | 1.270 | 0.864 | 0.00600 |
| | 1 1/4 | 1.660 | 0.140 | 1.380 | 0.1150 | 1.904 | 2.628 | 3.625 | 5.005 | 1.495 | 0.01040 |
| | 1 1/2 | 1.900 | 0.145 | 1.610 | 0.1342 | 2.592 | 4.173 | 6.718 | 10.82 | 2.036 | 0.01414 |
| | 2 | 2.375 | 0.154 | 2.067 | 0.1722 | 4.272 | 8.831 | 18.250 | 37.72 | 3.355 | 0.02330 |
| | 2 1/2 | 2.875 | 0.203 | 2.469 | 0.2057 | 6.096 | 15.051 | 37.161 | 91.75 | 4.788 | 0.03322 |
| | 3 | 3.500 | 0.216 | 3.068 | 0.2557 | 9.413 | 28.878 | 88.605 | 271.8 | 7.393 | 0.05130 |
| | 3 1/2 | 4.000 | 0.226 | 3.548 | 0.2957 | 12.59 | 44.663 | 158.51 | 562.2 | 9.886 | 0.06870 |
| | 4 | 4.500 | 0.237 | 4.026 | 0.3355 | 16.21 | 65.256 | 262.76 | 1058. | 12.730 | 0.08840 |
| | 5 | 5.563 | 0.258 | 5.047 | 0.4206 | 25.47 | 128.56 | 648.72 | 3275. | 20.006 | 0.1390 |
| | 6 | 6.625 | 0.280 | 6.065 | 0.5054 | 36.78 | 223.10 | 1352.8 | 8206. | 28.891 | 0.2006 |
| | 8 | 8.625 | 0.322 | 7.981 | 0.6651 | 63.70 | 508.36 | 4057.7 | 32380. | 50.027 | 0.3474 |
| | 10 | 10.75 | 0.365 | 10.02 | 0.8350 | 100.4 | 1006.0 | 10080. | 101000. | 78.855 | 0.5475 |
| | 12 | 12.75 | 0.406 | 11.938 | 0.9965 | 142.5 | 1701.3 | 20306. | 242470. | 111.93 | 0.7773 |
| | 14 | 14.0 | 0.438 | 13.124 | 1.0937 | 172.24 | 2260.5 | 29666. | 389340. | 135.28 | 0.9394 |
| | 16 | 16.0 | 0.500 | 15.000 | 1.250 | 225.0 | 3375.0 | 50625. | 759375. | 176.72 | 1.2272 |
| | 18 | 18.0 | 0.562 | 16.876 | 1.4063 | 284.8 | 4806.3 | 81111. | 1368820. | 223.68 | 1.5533 |
| | 20 | 20.0 | 0.593 | 18.814 | 1.5678 | 354.0 | 6659.5 | 125320. | 2357244. | 278.00 | 1.9305 |
| | 24 | 24.0 | 0.687 | 22.626 | 1.8855 | 511.9 | 11583. | 262040. | 5929784. | 402.07 | 2.7921 |
| Schedule 60 | | | | | | | | | | | |
| | 8 | 8.625 | 0.406 | 7.813 | 0.6511 | 61.04 | 476.93 | 3725.9 | 29113. | 47.94 | 0.3329 |
| | 10 | 10.75 | 0.500 | 9.750 | 0.8125 | 95.06 | 926.86 | 9036.4 | 88110. | 74.66 | 0.5185 |
| | 12 | 12.75 | 0.562 | 11.626 | 0.9688 | 135.16 | 1571.4 | 18268. | 212399. | 106.16 | 0.7372 |
| | 14 | 14.0 | 0.593 | 12.814 | 1.0678 | 164.20 | 2104.0 | 26962. | 345480. | 128.96 | 0.9556 |
| | 16 | 16.0 | 0.656 | 14.688 | 1.2240 | 215.74 | 3168.8 | 46544. | 683618. | 169.44 | 1.1766 |
| | 18 | 18.0 | 0.750 | 16.500 | 1.3750 | 272.25 | 4492.1 | 74120. | 1222982. | 213.83 | 1.4849 |
| | 20 | 20.0 | 0.812 | 18.376 | 1.5313 | 337.68 | 6205.2 | 114028. | 2095342. | 265.21 | 1.8417 |
| | 24 | 24.0 | 0.968 | 22.064 | 1.8387 | 486.82 | 10741. | 236994. | 5229036. | 382.35 | 2.6552 |
| Schedule 80 | | | | | | | | | | | |
| | 1/8 | 0.405 | 0.095 | 0.215 | 0.0179 | 0.0462 | 0.00994 | 0.002134 | 0.000459 | 0.036 | 0.00025 |
| | 1/4 | 0.540 | 0.119 | 0.302 | 0.0252 | 0.0912 | 0.0275 | 0.008317 | 0.002513 | 0.072 | 0.00050 |
| | 3/8 | 0.675 | 0.126 | 0.423 | 0.0353 | 0.1789 | 0.0757 | 0.03200 | 0.01354 | 0.141 | 0.00098 |
| | 1/2 | 0.840 | 0.147 | 0.546 | 0.0455 | 0.2981 | 0.1628 | 0.08886 | 0.04852 | 0.234 | 0.00163 |
| | 3/4 | 1.050 | 0.154 | 0.742 | 0.0618 | 0.5506 | 0.4085 | 0.3032 | 0.2249 | 0.433 | 0.00300 |
| | 1 | 1.315 | 0.179 | 0.957 | 0.0797 | 0.9158 | 0.8765 | 0.8387 | 0.8027 | 0.719 | 0.00499 |
| | 1 1/4 | 1.660 | 0.191 | 1.278 | 0.1065 | 1.633 | 2.087 | 2.6667 | 3.409 | 1.283 | 0.00891 |

Courtesy Crane Co., Technical Manual 410, Flow of Fluids.

D-14 (Continued). Commercial Wrought Steel Pipe Data (Based on ANSI B36.10 wall thicknesses)

| | Nominal Pipe Size | Outside Diameter | Thick-ness | Inside Diameter | | Inside Diameter Functions (In Inches) | | | | Transverse Internal Area | | |
|-------------------|-------------------|------------------|------------|-----------------|----------|--|-----------------------|-----------------------|-----------------------|--------------------------|----------|---------|
| | | | | <i>d</i> | <i>D</i> | <i>d</i> ² | <i>d</i> ³ | <i>d</i> ⁴ | <i>d</i> ⁵ | <i>a</i> | <i>A</i> | |
| | Inches | Inches | Inches | Inches | Feet | | | | | Sq. In. | Sq. Ft. | |
| Schedule 80—cont. | 1½ | 1.900 | 0.200 | 1.500 | 0.1250 | 2.250 | 3.375 | 5.062 | 7.594 | 1.767 | 0.01225 | |
| | 2 | 2.375 | 0.218 | 1.939 | 0.1616 | 3.760 | 7.290 | 14.136 | 27.41 | 2.953 | 0.02050 | |
| | 2½ | 2.875 | 0.276 | 2.323 | 0.1936 | 5.396 | 12.536 | 29.117 | 67.64 | 4.238 | 0.02942 | |
| | 3 | 3.5 | 0.300 | 2.900 | 0.2417 | 8.410 | 24.389 | 70.728 | 205.1 | 6.605 | 0.04587 | |
| | 3½ | 4.0 | 0.318 | 3.364 | 0.2803 | 11.32 | 38.069 | 128.14 | 430.8 | 8.888 | 0.06170 | |
| | 4 | 4.5 | 0.337 | 3.826 | 0.3188 | 14.64 | 56.006 | 214.33 | 819.8 | 11.497 | 0.07986 | |
| | 5 | 5.563 | 0.375 | 4.813 | 0.4011 | 23.16 | 111.49 | 536.38 | 2583. | 18.194 | 0.1263 | |
| | 6 | 6.625 | 0.432 | 5.761 | 0.4801 | 33.19 | 191.20 | 1101.6 | 6346. | 26.067 | 0.1810 | |
| | 8 | 8.625 | 0.500 | 7.625 | 0.6354 | 58.14 | 443.32 | 3380.3 | 25775. | 45.663 | 0.3171 | |
| | 10 | 10.75 | 0.593 | 9.564 | 0.7970 | 91.47 | 874.82 | 8366.8 | 80020. | 71.84 | 0.4989 | |
| | 12 | 12.75 | 0.687 | 11.376 | 0.9480 | 129.41 | 1472.2 | 16747. | 190523. | 101.64 | 0.7058 | |
| | 14 | 14.0 | 0.750 | 12.500 | 1.0417 | 156.25 | 1953.1 | 24414. | 305176. | 122.72 | 0.8522 | |
| Schedule 100 | 16 | 16.0 | 0.843 | 14.314 | 1.1928 | 204.89 | 2932.8 | 41980. | 600904. | 160.92 | 1.1175 | |
| | 18 | 18.0 | 0.937 | 16.126 | 1.3438 | 260.05 | 4193.5 | 67626. | 1090518. | 204.24 | 1.4183 | |
| | 20 | 20.0 | 1.031 | 17.938 | 1.4948 | 321.77 | 5771.9 | 103536. | 1857248. | 252.72 | 1.7550 | |
| | 24 | 24.0 | 1.218 | 21.564 | 1.7970 | 465.01 | 10027. | 216234. | 4662798. | 365.22 | 2.5362 | |
| | 8 | 8.625 | 0.593 | 7.439 | 0.6199 | 55.34 | 411.66 | 3062. | 22781. | 43.46 | 0.3018 | |
| | 10 | 10.75 | 0.718 | 9.314 | 0.7762 | 86.75 | 807.99 | 7526. | 69357. | 68.13 | 0.4732 | |
| | 12 | 12.75 | 0.843 | 11.064 | 0.9220 | 122.41 | 1354.4 | 14985. | 165791. | 96.14 | 0.6677 | |
| | 14 | 14.0 | 0.937 | 12.126 | 1.0105 | 147.04 | 1783.0 | 21621. | 262173. | 115.49 | 0.8020 | |
| | 16 | 16.0 | 1.031 | 13.938 | 1.1615 | 194.27 | 2707.7 | 37740. | 526020. | 152.58 | 1.0596 | |
| | 18 | 18.0 | 1.156 | 15.688 | 1.3057 | 246.11 | 3861.0 | 60572. | 950250. | 193.30 | 1.3423 | |
| | 20 | 20.0 | 1.281 | 17.438 | 1.4532 | 304.08 | 5302.6 | 92467. | 1612438. | 238.83 | 1.6585 | |
| | 24 | 24.0 | 1.531 | 20.938 | 1.7448 | 438.40 | 9179.2 | 192195. | 4024179. | 344.32 | 2.3911 | |
| Schedule 120 | 4 | 4.50 | 0.438 | 3.624 | 0.302 | 13.133 | 47.595 | 172.49 | 625.1 | 10.315 | 0.07163 | |
| | 5 | 5.563 | 0.500 | 4.563 | 0.3802 | 20.82 | 95.006 | 433.5 | 1978. | 16.35 | 0.1136 | |
| | 6 | 6.625 | 0.562 | 5.501 | 0.4584 | 30.26 | 166.47 | 915.7 | 5037. | 23.77 | 0.1650 | |
| | 8 | 8.625 | 0.718 | 7.189 | 0.5991 | 51.68 | 371.54 | 2671. | 19202. | 40.59 | 0.2819 | |
| | 10 | 10.75 | 0.843 | 9.064 | 0.7553 | 82.16 | 744.66 | 6750. | 61179. | 64.53 | 0.4481 | |
| | 12 | 12.75 | 1.000 | 10.750 | 0.8959 | 115.56 | 1242.3 | 13355. | 143563. | 90.76 | 0.6303 | |
| | 14 | 14.0 | 1.093 | 11.814 | 0.9845 | 139.57 | 1648.9 | 19480. | 230137. | 109.62 | 0.7612 | |
| | 16 | 16.0 | 1.218 | 13.564 | 1.1303 | 183.98 | 2495.5 | 33849. | 459133. | 144.50 | 1.0035 | |
| | 18 | 18.0 | 1.375 | 15.250 | 1.2708 | 232.56 | 3546.6 | 54085. | 824804. | 182.66 | 1.2684 | |
| | 20 | 20.0 | 1.500 | 17.000 | 1.4166 | 289.00 | 4913.0 | 83521. | 1419857. | 226.98 | 1.5762 | |
| | 24 | 24.0 | 1.812 | 20.376 | 1.6980 | 415.18 | 8459.7 | 172375. | 3512313. | 326.08 | 2.2645 | |
| | Schedule 140 | 8 | 8.625 | 0.812 | 7.001 | 0.5834 | 49.01 | 343.15 | 2402. | 16819. | 38.50 | 0.2673 |
| 10 | | 10.75 | 1.000 | 8.750 | 0.7292 | 76.56 | 669.92 | 5862. | 51291. | 60.13 | 0.4176 | |
| 12 | | 12.75 | 1.125 | 10.500 | 0.8750 | 110.25 | 1157.6 | 12155. | 127628. | 86.59 | 0.6013 | |
| 14 | | 14.0 | 1.250 | 11.500 | 0.9583 | 132.25 | 1520.9 | 17490. | 201136. | 103.87 | 0.7213 | |
| 16 | | 16.0 | 1.438 | 13.124 | 1.0937 | 172.24 | 2260.5 | 29666. | 389340. | 135.28 | 0.9394 | |
| 18 | | 18.0 | 1.562 | 14.876 | 1.2396 | 221.30 | 3292.0 | 48972. | 728502. | 173.80 | 1.2070 | |
| 20 | | 20.0 | 1.750 | 16.5 | 1.3750 | 272.25 | 4492.1 | 74120. | 1222981. | 213.82 | 1.4849 | |
| 24 | | 24.0 | 2.062 | 19.876 | 1.6563 | 395.06 | 7852.1 | 156069. | 3102022. | 310.28 | 2.1547 | |
| Schedule 160 | | ½ | 0.840 | 0.187 | 0.466 | 0.0388 | 0.2172 | 0.1012 | 0.04716 | 0.02197 | 0.1706 | 0.00118 |
| | | ¾ | 1.050 | 0.218 | 0.614 | 0.0512 | 0.3770 | 0.2315 | 0.1421 | 0.08726 | 0.2961 | 0.00206 |
| | | 1 | 1.315 | 0.250 | 0.815 | 0.0679 | 0.6642 | 0.5413 | 0.4412 | 0.3596 | 0.5217 | 0.00362 |
| | | 1¼ | 1.660 | 0.250 | 1.160 | 0.0966 | 1.346 | 1.561 | 1.811 | 2.100 | 1.057 | 0.00734 |
| | 1½ | 1.900 | 0.281 | 1.338 | 0.1115 | 1.790 | 2.395 | 3.205 | 4.288 | 1.406 | 0.00976 | |
| | 2 | 2.375 | 0.343 | 1.689 | 0.1407 | 2.853 | 4.818 | 8.138 | 13.74 | 2.241 | 0.01556 | |
| | 2½ | 2.875 | 0.375 | 2.125 | 0.1771 | 4.516 | 9.596 | 20.39 | 43.33 | 3.546 | 0.02463 | |
| | 3 | 3.50 | 0.438 | 2.624 | 0.2187 | 6.885 | 18.067 | 47.41 | 124.4 | 5.408 | 0.03755 | |
| | 4 | 4.50 | 0.531 | 3.438 | 0.2865 | 11.82 | 40.637 | 139.7 | 480.3 | 9.283 | 0.06447 | |
| | 5 | 5.563 | 0.625 | 4.313 | 0.3594 | 18.60 | 80.230 | 346.0 | 1492. | 14.61 | 0.1015 | |
| | 6 | 6.625 | 0.718 | 5.189 | 0.4324 | 26.93 | 139.72 | 725.0 | 3762. | 21.15 | 0.1469 | |
| | 8 | 8.625 | 0.906 | 6.813 | 0.5677 | 46.42 | 316.24 | 2155. | 14679. | 36.46 | 0.2532 | |
| 10 | 10.75 | 1.125 | 8.500 | 0.7083 | 72.25 | 614.12 | 5220. | 44371. | 56.75 | 0.3941 | | |
| 12 | 12.75 | 1.312 | 10.126 | 0.8438 | 102.54 | 1038.3 | 10514. | 106461. | 80.53 | 0.5592 | | |
| 14 | 14.0 | 1.406 | 11.188 | 0.9323 | 125.17 | 1400.4 | 15668. | 175292. | 98.31 | 0.6827 | | |
| 16 | 16.0 | 1.593 | 12.814 | 1.0678 | 164.20 | 2104.0 | 26961. | 345482. | 128.96 | 0.8956 | | |
| 18 | 18.0 | 1.781 | 14.438 | 1.2032 | 208.45 | 3009.7 | 43454. | 627387. | 163.72 | 1.1369 | | |
| 20 | 20.0 | 1.968 | 16.064 | 1.3387 | 258.05 | 4145.3 | 66590. | 1069715. | 202.67 | 1.4074 | | |
| 24 | 24.0 | 2.343 | 19.314 | 1.6095 | 373.03 | 7204.7 | 139152. | 2687582. | 292.98 | 2.0346 | | |

D-14
(Continued). Commercial Wrought Steel Pipe Data
(Based on ANSI B36.10 wall thicknesses)

| Nominal Pipe Size Inches | Outside Diameter Inches | Thick-ness Inches | Inside Diameter | | Inside Diameter Functions (In Inches) | | | | Transverse Internal Area | |
|---------------------------------|----------------------------|----------------------|--------------------|------------------|--|-----------------------|-----------------------|-----------------------|--------------------------|---------------------|
| | | | <i>d</i> Inches | <i>D</i> Feet | <i>d</i> ² | <i>d</i> ³ | <i>d</i> ⁴ | <i>d</i> ⁵ | <i>a</i> Sq. In. | <i>A</i> Sq. Ft. |
| Standard Wall Pipe | | | | | | | | | | |
| 1/8 | 0.405 | 0.068 | 0.269 | 0.0224 | 0.0724 | 0.0195 | 0.00524 | 0.00141 | 0.057 | 0.00040 |
| 1/4 | 0.540 | 0.088 | 0.364 | 0.0303 | 0.1325 | 0.0482 | 0.01756 | 0.00639 | 0.104 | 0.00072 |
| 3/8 | 0.675 | 0.091 | 0.493 | 0.0411 | 0.2430 | 0.1198 | 0.05905 | 0.02912 | 0.191 | 0.00133 |
| 1/2 | 0.840 | 0.109 | 0.622 | 0.0518 | 0.3869 | 0.2406 | 0.1497 | 0.0931 | 0.304 | 0.00211 |
| 3/4 | 1.050 | 0.113 | 0.824 | 0.0687 | 0.679 | 0.5595 | 0.4610 | 0.3799 | 0.533 | 0.00371 |
| 1 | 1.315 | 0.133 | 1.049 | 0.0874 | 1.100 | 1.154 | 1.210 | 1.270 | 0.864 | 0.00600 |
| 1 1/4 | 1.660 | 0.140 | 1.380 | 0.1150 | 1.904 | 2.628 | 3.625 | 5.005 | 1.495 | 0.01040 |
| 1 1/2 | 1.900 | 0.145 | 1.610 | 0.1342 | 2.592 | 4.173 | 6.718 | 10.82 | 2.036 | 0.01414 |
| 2 | 2.375 | 0.154 | 2.067 | 0.1722 | 4.272 | 8.831 | 18.250 | 37.72 | 3.355 | 0.02330 |
| 2 1/2 | 2.875 | 0.203 | 2.469 | 0.2057 | 6.096 | 15.051 | 37.161 | 91.75 | 4.788 | 0.03322 |
| 3 | 3.500 | 0.216 | 3.068 | 0.2557 | 9.413 | 28.878 | 88.605 | 271.8 | 7.393 | 0.05130 |
| 3 1/2 | 4.000 | 0.226 | 3.548 | 0.2957 | 12.59 | 44.663 | 158.51 | 562.2 | 9.886 | 0.06870 |
| 4 | 4.500 | 0.237 | 4.026 | 0.3355 | 16.21 | 65.256 | 262.76 | 1058. | 12.730 | 0.08840 |
| 5 | 5.563 | 0.258 | 5.047 | 0.4206 | 25.47 | 128.56 | 648.72 | 3275. | 20.006 | 0.1390 |
| 6 | 6.625 | 0.280 | 6.065 | 0.5054 | 36.78 | 223.10 | 1352.8 | 8206. | 28.891 | 0.2006 |
| 8 | 8.625 | 0.277 | 8.071 | 0.6725 | 65.14 | 525.75 | 4243.0 | 34248. | 51.161 | 0.3553 |
| | 8.625S | 0.322 | 7.981 | 0.6651 | 63.70 | 508.36 | 4057.7 | 32380. | 50.027 | 0.3474 |
| 10 | 10.75 | 0.279 | 10.192 | 0.8493 | 103.88 | 1058.7 | 10789. | 109876. | 81.585 | 0.5666 |
| | 10.75 | 0.307 | 10.136 | 0.8446 | 102.74 | 1041.4 | 10555. | 106987. | 80.691 | 0.5604 |
| | 10.75S | 0.365 | 10.020 | 0.8350 | 100.4 | 1006.0 | 10080. | 101000. | 78.855 | 0.5475 |
| 12 | 12.75 | 0.330 | 12.090 | 1.0075 | 146.17 | 1767.2 | 21366. | 258300. | 114.80 | 0.7972 |
| | 12.75S | 0.375 | 12.000 | 1.000 | 144.0 | 1728.0 | 20736. | 248800. | 113.10 | 0.7854 |
| Extra Strong Pipe | | | | | | | | | | |
| 1/8 | 0.405 | 0.095 | 0.215 | 0.0179 | 0.0462 | 0.00994 | 0.002134 | 0.000459 | 0.036 | 0.00025 |
| 1/4 | 0.540 | 0.119 | 0.302 | 0.0252 | 0.0912 | 0.0275 | 0.008317 | 0.002513 | 0.072 | 0.00050 |
| 3/8 | 0.675 | 0.126 | 0.423 | 0.0353 | 0.1789 | 0.0757 | 0.03201 | 0.01354 | 0.141 | 0.00098 |
| 1/2 | 0.840 | 0.147 | 0.546 | 0.0455 | 0.2981 | 0.1628 | 0.08886 | 0.04852 | 0.234 | 0.00163 |
| 3/4 | 1.050 | 0.154 | 0.742 | 0.0618 | 0.5506 | 0.4085 | 0.3032 | 0.2249 | 0.433 | 0.00300 |
| 1 | 1.315 | 0.129 | 0.957 | 0.0797 | 0.9158 | 0.8765 | 0.8387 | 0.8027 | 0.719 | 0.00499 |
| 1 1/4 | 1.660 | 0.191 | 1.278 | 0.1065 | 1.633 | 2.087 | 2.6667 | 3.409 | 1.283 | 0.00891 |
| 1 1/2 | 1.900 | 0.200 | 1.500 | 0.1250 | 2.250 | 3.375 | 5.062 | 7.594 | 1.767 | 0.01225 |
| 2 | 2.375 | 0.218 | 1.939 | 0.1616 | 3.760 | 7.290 | 14.136 | 27.41 | 2.953 | 0.02050 |
| 2 1/2 | 2.875 | 0.276 | 2.323 | 0.1936 | 5.396 | 12.536 | 29.117 | 67.64 | 4.238 | 0.02942 |
| 3 | 3.500 | 0.300 | 2.900 | 0.2417 | 8.410 | 24.389 | 70.728 | 205.1 | 6.605 | 0.04587 |
| 3 1/2 | 4.000 | 0.318 | 3.364 | 0.2803 | 11.32 | 38.069 | 128.14 | 430.8 | 9.888 | 0.06170 |
| 4 | 4.500 | 0.337 | 3.826 | 0.3188 | 14.64 | 56.006 | 214.33 | 819.8 | 11.497 | 0.07986 |
| 5 | 5.563 | 0.375 | 4.813 | 0.4011 | 23.16 | 111.49 | 536.6 | 2583. | 18.194 | 0.1263 |
| 6 | 6.625 | 0.432 | 5.761 | 0.4801 | 33.19 | 191.20 | 1101.6 | 6346. | 26.067 | 0.1810 |
| 8 | 8.625 | 0.500 | 7.625 | 0.6354 | 58.14 | 443.32 | 3380.3 | 25775. | 45.663 | 0.3171 |
| 10 | 10.75 | 0.500 | 9.750 | 0.8125 | 95.06 | 926.86 | 9036.4 | 88110. | 74.662 | 0.5185 |
| 12 | 12.75 | 0.500 | 11.750 | 0.9792 | 138.1 | 1622.2 | 19072. | 223970. | 108.434 | 0.7528 |
| Double Extra Strong Pipe | | | | | | | | | | |
| 1/2 | 0.840 | 0.294 | 0.252 | 0.0210 | 0.0635 | 0.0160 | 0.004032 | 0.00102 | 0.050 | 0.00035 |
| 3/4 | 1.050 | 0.308 | 0.434 | 0.0362 | 0.1884 | 0.0817 | 0.03549 | 0.01540 | 0.148 | 0.00103 |
| 1 | 1.315 | 0.358 | 0.599 | 0.0499 | 0.3588 | 0.2149 | 0.1287 | 0.07711 | 0.282 | 0.00196 |
| 1 1/4 | 1.660 | 0.382 | 0.896 | 0.0747 | 0.8028 | 0.7193 | 0.6445 | 0.5775 | 0.630 | 0.00438 |
| 1 1/2 | 1.900 | 0.400 | 1.100 | 0.0917 | 1.210 | 1.331 | 1.4641 | 1.611 | 0.950 | 0.00660 |
| 2 | 2.375 | 0.436 | 1.503 | 0.1252 | 2.259 | 3.395 | 5.1031 | 7.670 | 1.774 | 0.01232 |
| 2 1/2 | 2.875 | 0.552 | 1.771 | 0.1476 | 3.136 | 5.554 | 9.8345 | 17.42 | 2.464 | 0.01710 |
| 3 | 3.500 | 0.600 | 2.300 | 0.1917 | 5.290 | 12.167 | 27.984 | 64.36 | 4.155 | 0.02885 |
| 3 1/2 | 4.000 | 0.636 | 2.728 | 0.2273 | 7.442 | 20.302 | 55.383 | 151.1 | 5.845 | 0.04059 |
| 4 | 4.500 | 0.674 | 3.152 | 0.2627 | 9.935 | 31.315 | 98.704 | 311.1 | 7.803 | 0.05419 |
| 5 | 5.563 | 0.750 | 4.063 | 0.3386 | 16.51 | 67.072 | 272.58 | 1107. | 12.966 | 0.09006 |
| 6 | 6.625 | 0.864 | 4.897 | 0.4081 | 23.98 | 117.43 | 575.04 | 2816. | 18.835 | 0.1308 |
| 8 | 8.625 | 0.875 | 6.875 | 0.5729 | 47.27 | 324.95 | 2234.4 | 15360. | 37.122 | 0.2578 |

D-15 Stainless Steel Pipe Data (Based on ANSI B36.19 wall thicknesses)

| Nominal Pipe Size | Outside Diameter | Thick-ness | Inside Diameter | | Inside Diameter Functions (In Inches) | | | | Transverse Internal Area | |
|----------------------|---|------------|-----------------|--------|---------------------------------------|----------------|----------------|----------------|--------------------------|---------|
| | | | d | D | d ² | d ³ | d ⁴ | d ⁵ | a | A |
| Inches | Inches | Inches | Inches | Feet | | | | | Sq. In. | Sq. Ft. |
| Schedule 5 S | | | | | | | | | | |
| 1/2 | 0.840 | 0.065 | 0.710 | 0.0592 | 0.504 | 0.358 | 0.254 | 0.1804 | 0.396 | 0.00275 |
| 3/4 | 1.050 | 0.065 | 0.920 | 0.0767 | 0.846 | 0.779 | 0.716 | 0.659 | 0.664 | 0.00461 |
| 1 | 1.315 | 0.065 | 1.185 | 0.0988 | 1.404 | 1.664 | 1.972 | 2.337 | 1.103 | 0.00766 |
| 1 1/4 | 1.660 | 0.065 | 1.530 | 0.1275 | 2.341 | 3.582 | 5.480 | 8.384 | 1.839 | 0.01277 |
| 1 1/2 | 1.900 | 0.065 | 1.770 | 0.1475 | 3.133 | 5.545 | 9.815 | 17.37 | 2.461 | 0.01709 |
| 2 | 2.375 | 0.065 | 2.245 | 0.1871 | 5.040 | 11.31 | 25.40 | 57.03 | 3.958 | 0.02749 |
| 2 1/2 | 2.875 | 0.083 | 2.709 | 0.2258 | 7.339 | 19.88 | 53.86 | 145.9 | 5.764 | 0.04003 |
| 3 | 3.500 | 0.083 | 3.334 | 0.2778 | 11.12 | 37.06 | 123.6 | 411.9 | 8.733 | 0.06065 |
| 3 1/2 | 4.000 | 0.083 | 3.834 | 0.3195 | 14.70 | 56.36 | 216.1 | 828.4 | 11.545 | 0.08017 |
| 4 | 4.500 | 0.083 | 4.334 | 0.3612 | 18.78 | 81.41 | 352.8 | 1529. | 14.750 | 0.1024 |
| 5 | 5.563 | 0.109 | 5.345 | 0.4454 | 28.57 | 152.7 | 816.2 | 4363. | 22.439 | 0.1558 |
| 6 | 6.625 | 0.109 | 6.407 | 0.5339 | 41.05 | 263.0 | 1685. | 10796. | 32.241 | 0.2239 |
| 8 | 8.625 | 0.109 | 8.407 | 0.7006 | 70.68 | 594.2 | 4995. | 41996. | 55.512 | 0.3855 |
| 10 | 10.750 | 0.134 | 10.482 | 0.8375 | 109.9 | 1152. | 12072. | 126538. | 86.315 | 0.5994 |
| 12 | 12.750 | 0.156 | 12.438 | 1.0365 | 154.7 | 1924. | 23933. | 297682. | 121.50 | 0.8438 |
| Schedule 10 S | | | | | | | | | | |
| 1/8 | 0.405 | 0.049 | 0.307 | 0.0256 | 0.0942 | 0.0289 | 0.00888 | 0.00273 | 0.074 | 0.00051 |
| 1/4 | 0.540 | 0.065 | 0.410 | 0.0342 | 0.1681 | 0.0689 | 0.02826 | 0.01159 | 0.132 | 0.00092 |
| 3/8 | 0.675 | 0.065 | 0.545 | 0.0454 | 0.2970 | 0.1619 | 0.08822 | 0.04808 | 0.233 | 0.00162 |
| 1/2 | 0.840 | 0.083 | 0.674 | 0.0562 | 0.4543 | 0.3062 | 0.2064 | 0.1391 | 0.357 | 0.00248 |
| 3/4 | 1.050 | 0.083 | 0.884 | 0.0737 | 0.7815 | 0.6908 | 0.6107 | 0.5398 | 0.614 | 0.00426 |
| 1 | 1.315 | 0.109 | 1.097 | 0.0914 | 1.203 | 1.320 | 1.448 | 1.589 | 0.945 | 0.00656 |
| 1 1/4 | 1.660 | 0.109 | 1.442 | 0.1202 | 2.079 | 2.998 | 4.324 | 6.235 | 1.633 | 0.01134 |
| 1 1/2 | 1.900 | 0.109 | 1.682 | 0.1402 | 2.829 | 4.759 | 8.004 | 13.46 | 2.222 | 0.01543 |
| 2 | 2.375 | 0.109 | 2.157 | 0.1798 | 4.653 | 10.04 | 21.65 | 46.69 | 3.654 | 0.02538 |
| 2 1/2 | 2.875 | 0.120 | 2.635 | 0.2196 | 6.943 | 18.30 | 48.21 | 127.0 | 5.453 | 0.03787 |
| 3 | 3.500 | 0.120 | 3.260 | 0.2717 | 10.63 | 34.65 | 112.9 | 368.2 | 8.347 | 0.05796 |
| 3 1/2 | 4.000 | 0.120 | 3.760 | 0.3133 | 14.14 | 53.16 | 199.9 | 751.5 | 11.11 | 0.07712 |
| 4 | 4.500 | 0.120 | 4.260 | 0.3550 | 18.15 | 77.31 | 329.3 | 1403. | 14.26 | 0.09899 |
| 5 | 5.563 | 0.134 | 5.295 | 0.4413 | 28.04 | 148.5 | 786.1 | 4162. | 22.02 | 0.1529 |
| 6 | 6.625 | 0.134 | 6.357 | 0.5298 | 40.41 | 256.9 | 1633. | 10382. | 31.74 | 0.2204 |
| 8 | 8.625 | 0.148 | 8.329 | 0.6941 | 69.37 | 577.8 | 4813. | 40083. | 54.48 | 0.3784 |
| 10 | 10.750 | 0.165 | 10.420 | 0.8683 | 108.6 | 1131. | 11789. | 122840. | 85.29 | 0.5923 |
| 12 | 12.750 | 0.180 | 12.390 | 1.0325 | 153.5 | 1902. | 23566. | 291982. | 120.6 | 0.8372 |
| Schedule 40 S | | | | | | | | | | |
| 1/8 to 12 | Values are the same, size for size, as those shown on the facing page for Standard Wall Pipe (heaviest weight on 8, 10, and 12-inch sizes). | | | | | | | | | |
| Schedule 80 S | | | | | | | | | | |
| 1/8 to 12 | Values are the same, size for size, as those shown on the facing page for Extra Strong Pipe. | | | | | | | | | |

Courtesy Crane Co., Technical Manual 410, Flow of Fluids.

D-16 Properties of Pipe

Tabulated below are the most generally required data used in piping design. This table is believed to be the most comprehensive published up to this time. Many thicknesses traditionally included in such tables have been omitted because of their having become obsolete through disuse and lack of coverage by any Standard.

Sizes and thicknesses listed herein are covered by the following Standards:—

- 1) American National Standard Institute B36.10
- 2) American National Standard Institute B36.19
- 3) American Petroleum Institute Standard API 5L
- 4) American Petroleum Institute Standard API 5LX
- 5) New United States Legal Standard for Steel Plate Gauges.

Sizes and thicknesses to which no Standard designation applies are largely the more commonly used dimensions to which Taylor Forge Electric Fusion Welded Pipe is produced for a wide variety of applications including river crossings, penstocks, power plant and other piping.

All data is computed from the *nominal* dimensions listed and the effect of tolerances is not taken into account. Values are computed by application of the following formulas:

Radius of Gyration: $R = \frac{\sqrt{D^2 + d^2}}{4}$

Moment of Inertia: $I = R^2 A$

Section Modulus: $Z = \frac{I}{0.5 D}$

ANSI American National Standards Institute

| Pipe Size | Nominal | Designation | Wall Thickness | Inside Diam. | Weight per Foot | Wt. of Water per Ft. of Pipe | Sq. Ft. Outside Surface per Ft. | Sq. Ft. Inside Surface per Ft. | Transverse Area | Area of Metal | Moment of Inertia | Section Modulus | Radius of Gyration |
|-----------|---------------|-------------|----------------|--------------|-----------------|------------------------------|---------------------------------|--------------------------------|------------------|------------------|-------------------|------------------|--------------------|
| | Outside Diam. | | | | | | | | in. ² | in. ² | in. ⁴ | in. ³ | in. |
| | D | | | d | | | | a | A | I | Z | R | |
| 1/8 | .405 | 10S | .049 | .307 | .186 | .0320 | .106 | .0804 | .0740 | .0548 | .00090 | .00440 | .1270 |
| | | Std. | .068 | .269 | .244 | .0246 | .106 | .0705 | .0568 | .0720 | .00106 | .00530 | .1215 |
| | | X-Stg. | .095 | .215 | .314 | .0157 | .106 | .0563 | .0364 | .0925 | .00122 | .00600 | .1146 |
| 1/4 | .540 | 10S | .065 | .410 | .330 | .0570 | .141 | .1073 | .1320 | .0970 | .00280 | .01030 | .1695 |
| | | Std. | .088 | .364 | .424 | .0451 | .141 | .0955 | .1041 | .1250 | .00331 | .01230 | .1628 |
| | | X-Stg. | .119 | .302 | .535 | .0310 | .141 | .0794 | .0716 | .1574 | .00378 | .01395 | .1547 |
| 3/8 | .675 | 10S | .065 | .545 | .423 | .1010 | .177 | .1427 | .2333 | .1245 | .00590 | .01740 | .2160 |
| | | Std. | .091 | .493 | .567 | .0827 | .177 | .1295 | .1910 | .1670 | .00730 | .02160 | .2090 |
| | | X-Stg. | .126 | .423 | .738 | .0609 | .177 | .1106 | .1405 | .2173 | .00862 | .02554 | .1991 |
| 1/2 | .840 | 10S | .083 | .670 | .671 | .1550 | .220 | .1764 | .3568 | .1974 | .01430 | .03410 | .2692 |
| | | Std. | .109 | .622 | .850 | .1316 | .220 | .1637 | .3040 | .2503 | .01710 | .04070 | .2613 |
| | | X-Stg. | .147 | .546 | 1.087 | .1013 | .220 | .1433 | .2340 | .3200 | .02010 | .04780 | .2505 |
| | | 160 | .138 | .464 | 1.310 | .0740 | .220 | .1220 | .1706 | .3836 | .02213 | .05269 | .2402 |
| XX-Stg. | .294 | .252 | 1.714 | .0216 | .220 | .0660 | .0499 | .5043 | .02424 | .05772 | .2192 | | |
| 3/4 | 1.050 | 10S | .083 | .884 | .857 | .2660 | .275 | .2314 | .6138 | .2522 | .02970 | .05660 | .3430 |
| | | Std. | .113 | .824 | 1.130 | .2301 | .275 | .2168 | .5330 | .3326 | .03704 | .07055 | .3337 |
| | | X-Stg. | .154 | .742 | 1.473 | .1875 | .275 | .1948 | .4330 | .4335 | .04479 | .08531 | .3214 |
| 160 | .219 | .612 | 1.940 | .1280 | .275 | .1607 | .2961 | .5698 | .05270 | .10038 | .3041 | | |
| XX-Stg. | .308 | .434 | 2.440 | .0633 | .275 | .1137 | .1479 | .7180 | .05792 | .11030 | .2840 | | |
| 1 | 1.315 | 10S | .109 | 1.097 | 1.404 | .4090 | .344 | .2872 | .9448 | .4129 | .07560 | .1150 | .4282 |
| | | Std. | .133 | 1.049 | 1.678 | .3740 | .344 | .2740 | .8640 | .4939 | .08734 | .1328 | .4205 |
| | | X-Stg. | .179 | .957 | 2.171 | .3112 | .344 | .2520 | .7190 | .6388 | .10560 | .1606 | .4066 |
| 160 | .250 | .815 | 2.850 | .2261 | .344 | .2134 | .5217 | .8364 | .12516 | .1903 | .3868 | | |
| XX-Stg. | .358 | .599 | 3.659 | .1221 | .344 | .1570 | .2818 | 1.0760 | .14050 | .2136 | .3613 | | |
| 1 1/4 | 1.660 | 10S | .109 | 1.442 | 1.806 | .7080 | .434 | .3775 | 1.633 | .5314 | .1606 | .1934 | .5499 |
| | | Std. | .140 | 1.380 | 2.272 | .6471 | .434 | .3620 | 1.495 | .6685 | .1947 | .2346 | .5397 |
| | | | .191 | 1.278 | 2.996 | .5553 | .434 | .3356 | 1.283 | .8815 | .2418 | .2913 | .5237 |
| | | .250 | 1.160 | 3.764 | .4575 | .434 | .3029 | 1.057 | 1.1070 | .2833 | .3421 | .5063 | |
| | | .382 | .896 | 5.214 | .2732 | .434 | .2331 | .6305 | 1.5340 | .3411 | .4110 | .4716 | |

Courtesy Taylor Forge Division, Energy Products Group, Gulf and Western Mfg. Co., by permission.

D-16
(Continued). Properties of Pipe

| Nominal | | Designation | Wall Thickness | Inside Diam. | Weight per Foot | Wt. of Water per Ft. of Pipe | Sq. Ft. Outside Surface per Ft. | Sq. Ft. Inside Surface per Ft. | Transverse Area in. ² | Area of Metal in. ² | Moment of Inertia in. ⁴ | Section Modulus in. ³ | Radius of Gyration in. |
|------------|---------------|----------------------|----------------------|-------------------------|-------------------------|------------------------------|---------------------------------|--------------------------------|----------------------------------|--------------------------------|------------------------------------|----------------------------------|-------------------------|
| Pipe Size | Outside Diam. | | | | | | | | | | | | |
| | D | | | d | | | | | a | A | I | Z | R |
| 1½ | 1.900 | 10S Std. | .109 .145 | 1.682 1.610 | 2.085 2.717 | .9630 .8820 | .497 .497 | .4403 .4213 | 2.221 2.036 | .613 .800 | .2469 .3099 | .2599 .3262 | .6344 .6226 |
| | | X-Stg. 160 | .200 .281 | 1.500 1.337 | 3.631 4.862 | .7648 .6082 | .497 .497 | .3927 .3519 | 1.767 1.405 | 1.068 1.430 | .3912 .4826 | .4118 .5080 | .6052 .5809 |
| | | XX-Stg. | .400 | 1.100 | 6.408 | .4117 | .497 | .2903 | .950 | 1.885 | .5678 | .5977 | .5489 |
| 2 | 2.375 | 10S Std. | .109 .154 | 2.157 2.067 | 2.638 3.652 | 1.583 1.452 | .622 .622 | .5647 .5401 | 3.654 3.355 | .775 1.075 | .5003 .6657 | .4213 .5606 | .8034 .7871 |
| | | X-Stg. | .218 | 1.939 | 5.022 | 1.279 | .622 | .5074 | 2.953 | 1.477 | .8679 | .7309 | .7665 |
| | | -- 160 XX-Stg. | .250 .344 .436 | 1.875 1.687 1.503 | 5.673 7.450 9.029 | 1.196 .970 .769 | .622 .622 .622 | .4920 .4422 .3929 | 2.761 2.240 1.774 | 1.669 2.190 2.656 | .9555 1.162 1.311 | .8046 .9790 1.1040 | .7565 .7286 .7027 |
| 2½ | 2.875 | 10S Std. | .120 .203 | 2.635 2.469 | 3.53 5.79 | 2.360 2.072 | .753 .753 | .6900 .6462 | 5.453 4.788 | 1.038 1.704 | .9878 1.530 | .6872 1.064 | .9755 .9474 |
| | | X-Stg. 160 | .276 .375 | 2.323 2.125 | 7.66 10.01 | 1.834 1.535 | .753 .753 | .6095 .5564 | 4.238 3.547 | 2.254 2.945 | 1.924 2.353 | 1.339 1.638 | .9241 .8938 |
| | | XX-Stg. | .552 | 1.771 | 13.69 | 1.067 | .753 | .4627 | 2.464 | 4.028 | 2.871 | 1.997 | .8442 |
| 3 | 3.500 | 10S | .120 | 3.260 | 4.33 | 3.62 | .916 | .853 | 8.346 | 1.272 | 1.821 | 1.041 | 1.196 |
| | | API | .125 | 3.250 | 4.52 | 3.60 | .916 | .851 | 8.300 | 1.329 | 1.900 | 1.086 | 1.195 |
| | | API | .156 | 3.188 | 5.58 | 3.46 | .916 | .835 | 7.982 | 1.639 | 2.298 | 1.313 | 1.184 |
| | | API Std. | .188 | 3.125 | 6.65 | 3.34 | .916 | .819 | 7.700 | 1.958 | 2.700 | 1.545 | 1.175 |
| | | API | .216 | 3.068 | 7.57 | 3.20 | .916 | .802 | 7.393 | 2.228 | 3.017 | 1.724 | 1.164 |
| | | API | .250 | 3.000 | 8.68 | 3.06 | .916 | .785 | 7.184 | 2.553 | 3.388 | 1.936 | 1.152 |
| 3½ | 4.000 | API | .281 | 2.938 | 9.65 | 2.94 | .916 | .769 | 6.780 | 2.842 | 3.819 | 2.182 | 1.142 |
| | | X-Stg. 160 | .300 | 2.900 | 10.25 | 2.86 | .916 | .761 | 6.605 | 3.016 | 3.892 | 2.225 | 1.136 |
| | | XX-Stg. | .438 | 2.624 | 14.32 | 2.34 | .916 | .687 | 5.407 | 4.214 | 5.044 | 2.882 | 1.094 |
| | | API | .600 | 2.300 | 18.58 | 1.80 | .916 | .601 | 4.155 | 5.466 | 5.993 | 3.424 | 1.047 |
| | | 10S | .120 | 3.760 | 4.97 | 4.81 | 1.047 | .984 | 11.10 | 1.46 | 2.754 | 1.377 | 1.372 |
| | | API | .125 | 3.750 | 5.18 | 4.79 | 1.047 | .982 | 11.04 | 1.52 | 2.859 | 1.430 | 1.371 |
| 4 | 4.500 | API | .156 | 3.688 | 6.41 | 4.63 | 1.047 | .966 | 10.68 | 1.88 | 3.485 | 1.743 | 1.360 |
| | | API | .188 | 3.624 | 7.71 | 4.48 | 1.047 | .950 | 10.32 | 2.27 | 4.130 | 2.065 | 1.350 |
| | | API Std. | .226 | 3.548 | 9.11 | 4.28 | 1.047 | .929 | 9.89 | 2.68 | 4.788 | 2.394 | 1.337 |
| | | API | .250 | 3.500 | 10.02 | 4.17 | 1.047 | .916 | 9.62 | 2.94 | 5.201 | 2.601 | 1.329 |
| | | API | .281 | 3.438 | 11.17 | 4.02 | 1.047 | .900 | 9.28 | 3.29 | 5.715 | 2.858 | 1.319 |
| | | X-Stg. 120 | .318 | 3.364 | 12.51 | 3.85 | 1.047 | .880 | 8.89 | 3.68 | 6.280 | 3.140 | 1.307 |
| 4 | 4.500 | XX-Stg. | .636 | 2.728 | 22.85 | 2.53 | 1.047 | .716 | 5.84 | 6.72 | 9.848 | 4.924 | 1.210 |
| | | 10S | .120 | 4.260 | 5.61 | 6.18 | 1.178 | 1.115 | 14.25 | 1.65 | 3.97 | 1.761 | 1.550 |
| | | API | .125 | 4.250 | 5.84 | 6.15 | 1.178 | 1.113 | 14.19 | 1.72 | 4.12 | 1.829 | 1.548 |
| | | API | .156 | 4.188 | 7.24 | 5.97 | 1.178 | 1.096 | 13.77 | 2.13 | 5.03 | 2.235 | 1.537 |
| | | API | .188 | 4.124 | 8.56 | 5.80 | 1.178 | 1.082 | 13.39 | 2.52 | 5.86 | 2.600 | 1.525 |
| | | API Std. | .219 | 4.062 | 10.02 | 5.62 | 1.178 | 1.063 | 12.96 | 2.94 | 6.77 | 3.867 | 1.516 |
| | | API | .237 | 4.026 | 10.79 | 5.51 | 1.178 | 1.055 | 12.73 | 3.17 | 7.23 | 4.214 | 1.510 |
| | | API | .250 | 4.000 | 11.35 | 5.45 | 1.178 | 1.049 | 12.57 | 3.34 | 7.56 | 3.360 | 1.505 |
| | | API | .281 | 3.938 | 12.67 | 5.27 | 1.178 | 1.031 | 12.17 | 3.73 | 8.33 | 3.703 | 1.495 |
| | | API | .312 | 3.876 | 14.00 | 5.12 | 1.178 | 1.013 | 11.80 | 4.11 | 9.05 | 4.020 | 1.482 |
| X-Stg. 120 | .337 | 3.826 | 14.98 | 4.98 | 1.178 | 1.002 | 11.50 | 4.41 | 9.61 | 4.271 | 1.477 | | |
| 4 | 4.500 | 120 | .438 | 3.624 | 19.00 | 4.47 | 1.178 | .949 | 10.32 | 5.59 | 11.65 | 5.177 | 1.444 |
| | | -- | .500 | 3.500 | 21.36 | 4.16 | 1.178 | .916 | 9.62 | 6.28 | 12.77 | 5.676 | 1.425 |
| 4 | 4.500 | 160 | .531 | 3.438 | 22.60 | 4.02 | 1.178 | .900 | 9.28 | 6.62 | 13.27 | 5.900 | 1.416 |
| | | XX-Stg. | .674 | 3.152 | 27.54 | 3.38 | 1.178 | .826 | 7.80 | 8.10 | 15.28 | 6.793 | 1.374 |

900 APPENDIX D

D-16 (Continued). Properties of Pipe

Table with columns: Nominal Pipe Size, Outside Diam. D, Designation, Wall Thickness, Inside Diam. d, Weight per Foot, Wt. of Water per Ft. of Pipe, Sq. Ft. Outside Surface per Ft., Sq. Ft. Inside Surface per Ft., Transverse Area in.² a, Area of Metal in.² A, Moment of Inertia in.⁴ I, Section Modulus in.³ Z, Radius of Gyration in. R. Rows are grouped by pipe size (5, 6, 8) and nominal diameter (5.563, 6.625, 8.625).

D-16 (Continued). Properties of Pipe

| Nominal | | Designation | Wall Thickness | Inside Diam. d | Weight per Foot | Wt. of Water per Ft. of Pipe | Sq. Ft. Outside Surface per Ft. | Sq. Ft. Inside Surface per Ft. | Transverse Area in. ² | Area of Metal in. ² | Moment of Inertia in. ⁴ | Section Modulus in. ³ | Radius of Gyration in. |
|-----------|-----------------|-------------|----------------|----------------|-----------------|------------------------------|---------------------------------|--------------------------------|----------------------------------|--------------------------------|------------------------------------|----------------------------------|------------------------|
| Pipe Size | Outside Diam. D | | | | | | | | | | | | |
| 10 | 10.750 | 12 Ga. | .104 | 10.542 | 11.83 | 37.8 | 2.81 | 2.76 | 87.3 | 3.48 | 49.3 | 9.16 | 3.76 |
| | | 10 Ga. | .134 | 10.482 | 15.21 | 37.4 | 2.81 | 2.74 | 86.3 | 4.47 | 63.0 | 11.71 | 3.75 |
| | | 8 Ga. | .164 | 10.422 | 18.56 | 37.0 | 2.81 | 2.73 | 85.3 | 5.45 | 76.4 | 14.22 | 3.74 |
| | | 10S | .165 | 10.420 | 18.65 | 36.9 | 2.81 | 2.73 | 85.3 | 5.50 | 76.8 | 14.29 | 3.74 |
| | | API | .188 | 10.374 | 21.12 | 36.7 | 2.81 | 2.72 | 84.5 | 6.20 | 86.5 | 16.10 | 3.74 |
| | | 6 Ga. | .194 | 10.362 | 21.89 | 36.6 | 2.81 | 2.71 | 84.3 | 6.43 | 89.7 | 16.68 | 3.73 |
| | | API | .203 | 10.344 | 22.86 | 36.5 | 2.81 | 2.71 | 84.0 | 6.71 | 93.3 | 17.35 | 3.73 |
| | | API | .219 | 10.310 | 24.60 | 36.2 | 2.81 | 2.70 | 83.4 | 7.24 | 100.5 | 18.70 | 3.72 |
| | | 3 Ga. | .239 | 10.272 | 28.05 | 35.9 | 2.81 | 2.69 | 82.9 | 7.89 | 109.2 | 20.32 | 3.72 |
| | | 20 | .250 | 10.250 | 28.03 | 35.9 | 2.81 | 2.68 | 82.6 | 8.26 | 113.6 | 21.12 | 3.71 |
| | | API | .279 | 10.192 | 31.20 | 35.3 | 2.81 | 2.66 | 81.6 | 9.18 | 125.9 | 23.42 | 3.70 |
| | | 30 | .307 | 10.136 | 34.24 | 35.0 | 2.81 | 2.65 | 80.7 | 10.07 | 137.4 | 25.57 | 3.69 |
| | | API | .344 | 10.062 | 38.26 | 34.5 | 2.81 | 2.63 | 79.5 | 11.25 | 152.3 | 28.33 | 3.68 |
| | | Std. | .365 | 10.020 | 40.48 | 34.1 | 2.81 | 2.62 | 78.9 | 11.91 | 160.7 | 29.90 | 3.67 |
| | | API | .438 | 9.874 | 48.28 | 33.2 | 2.81 | 2.58 | 76.6 | 14.19 | 188.8 | 35.13 | 3.65 |
| | | X-Stg. | .500 | 9.750 | 54.74 | 32.3 | 2.81 | 2.55 | 74.7 | 16.10 | 212.0 | 39.43 | 3.63 |
| | | 80 | .594 | 9.562 | 64.40 | 31.1 | 2.81 | 2.50 | 71.8 | 18.91 | 244.9 | 45.56 | 3.60 |
| | | 100 | .719 | 9.312 | 77.00 | 29.5 | 2.81 | 2.44 | 68.1 | 22.62 | 286.2 | 53.25 | 3.56 |
| | | -- | .750 | 9.250 | 80.10 | 29.1 | 2.81 | 2.42 | 67.2 | 23.56 | 296.2 | 55.10 | 3.54 |
| | | 120 | .844 | 9.062 | 89.20 | 27.9 | 2.81 | 2.37 | 64.5 | 26.23 | 324.3 | 60.34 | 3.51 |
| 140 | 1.000 | 8.750 | 104.20 | 26.1 | 2.81 | 2.29 | 60.1 | 30.63 | 367.8 | 68.43 | 3.46 | | |
| 160 | 1.125 | 8.500 | 116.00 | 24.6 | 2.81 | 2.22 | 56.7 | 34.01 | 399.4 | 74.31 | 3.43 | | |
| 12 | 12.750 | 12 Ga. | .104 | 12.542 | 14.1 | 53.6 | 3.34 | 3.28 | 123.5 | 4.13 | 82.6 | 12.9 | 4.47 |
| | | 10 Ga. | .134 | 12.482 | 18.1 | 53.0 | 3.34 | 3.27 | 122.4 | 5.31 | 105.7 | 16.6 | 4.46 |
| | | 8 Ga. | .164 | 12.422 | 22.1 | 52.5 | 3.34 | 3.25 | 121.2 | 6.48 | 128.4 | 20.1 | 4.45 |
| | | 10S | .180 | 12.390 | 24.2 | 52.2 | 3.34 | 3.24 | 120.6 | 7.11 | 140.4 | 22.0 | 4.44 |
| | | 6 Ga. | .194 | 12.362 | 26.0 | 52.0 | 3.34 | 3.23 | 120.0 | 7.65 | 150.9 | 23.7 | 4.44 |
| | | API | .203 | 12.344 | 27.2 | 52.0 | 3.34 | 3.23 | 119.9 | 7.99 | 157.2 | 24.7 | 4.43 |
| | | API | .219 | 12.312 | 29.3 | 51.7 | 3.34 | 3.22 | 119.1 | 8.52 | 167.6 | 26.3 | 4.43 |
| | | 3 Ga. | .239 | 12.272 | 32.0 | 51.3 | 3.34 | 3.21 | 118.3 | 9.39 | 183.8 | 28.8 | 4.42 |
| | | 20 | .250 | 12.250 | 33.4 | 51.3 | 3.34 | 3.12 | 118.0 | 9.84 | 192.3 | 30.2 | 4.42 |
| | | API | .281 | 12.188 | 37.4 | 50.6 | 3.34 | 3.19 | 116.7 | 11.01 | 214.1 | 33.6 | 4.41 |
| | | API | .312 | 12.126 | 41.5 | 50.1 | 3.34 | 3.17 | 115.5 | 12.19 | 236.0 | 37.0 | 4.40 |
| | | 30 | .330 | 12.090 | 43.8 | 49.7 | 3.34 | 3.16 | 114.8 | 12.88 | 248.5 | 39.0 | 4.39 |
| | | API | .344 | 12.062 | 45.5 | 49.7 | 3.34 | 3.16 | 114.5 | 13.46 | 259.0 | 40.7 | 4.38 |
| | | Std. | .375 | 12.000 | 49.6 | 48.9 | 3.34 | 3.14 | 113.1 | 14.58 | 279.3 | 43.8 | 4.37 |
| | | 40 | .406 | 11.938 | 53.6 | 48.5 | 3.34 | 3.13 | 111.9 | 15.74 | 300.3 | 47.1 | 4.37 |
| | | API | .438 | 11.874 | 57.5 | 48.2 | 3.34 | 3.11 | 111.0 | 16.95 | 321.0 | 50.4 | 4.35 |
| | | X-Stg. | .500 | 11.750 | 65.4 | 46.9 | 3.34 | 3.08 | 108.4 | 19.24 | 361.5 | 56.7 | 4.33 |
| | | 60 | .562 | 11.626 | 73.2 | 46.0 | 3.34 | 3.04 | 106.2 | 21.52 | 400.5 | 62.8 | 4.31 |
| | | -- | .625 | 11.500 | 80.9 | 44.9 | 3.34 | 3.01 | 103.8 | 23.81 | 438.7 | 68.8 | 4.29 |
| | | 80 | .688 | 11.374 | 88.6 | 44.0 | 3.34 | 2.98 | 101.6 | 26.03 | 475.2 | 74.6 | 4.27 |
| -- | .750 | 11.250 | 96.2 | 43.1 | 3.34 | 2.94 | 99.4 | 28.27 | 510.7 | 80.1 | 4.25 | | |
| 100 | .844 | 11.062 | 108.0 | 41.6 | 3.34 | 2.90 | 96.1 | 31.53 | 561.8 | 88.1 | 4.22 | | |
| -- | .875 | 11.000 | 110.9 | 41.1 | 3.34 | 2.88 | 95.0 | 32.64 | 578.5 | 90.7 | 4.21 | | |
| 120 | 1.000 | 10.750 | 125.5 | 39.3 | 3.34 | 2.81 | 90.8 | 36.91 | 641.7 | 100.7 | 4.17 | | |
| 140 | 1.125 | 10.500 | 140.0 | 37.5 | 3.34 | 2.75 | 86.6 | 41.08 | 700.7 | 109.9 | 4.13 | | |
| -- | 1.250 | 10.250 | 153.6 | 35.8 | 3.34 | 2.68 | 82.5 | 45.16 | 755.5 | 118.5 | 4.09 | | |
| 160 | 1.312 | 10.126 | 161.0 | 34.9 | 3.34 | 2.65 | 80.5 | 47.14 | 781.3 | 122.6 | 4.07 | | |
| -- | 1.375 | 10.000 | 167.2 | 34.0 | 3.34 | 2.62 | 78.5 | 49.14 | 807.2 | 126.6 | 4.05 | | |
| -- | 1.500 | 9.750 | 180.4 | 32.4 | 3.34 | 2.55 | 74.7 | 53.01 | 853.8 | 133.9 | 4.01 | | |

902 APPENDIX D

D-16
(Continued). Properties of Pipe

| Nominal | | Designation | Wall Thickness | Inside Diam. d | Weight per Foot | Wt. of Water per Ft. of Pipe | Sq. Ft. Outside Surface per Ft. | Sq. Ft. Inside Surface per Ft. | Transverse Area in. ² | Area of Metal in. ² | Moment of Inertia in. ⁴ | Section Modulus in. ³ | Radius of Gyration in. |
|-----------|-----------------|-------------|----------------|----------------|-----------------|------------------------------|---------------------------------|--------------------------------|----------------------------------|--------------------------------|------------------------------------|----------------------------------|------------------------|
| Pipe Size | Outside Diam. D | | | | | | | | | | | | |
| 14 | 14.000 | 10 Ga. | .134 | 13.732 | 20 | 64.2 | 3.67 | 3.59 | 148.1 | 5.84 | 140.4 | 20.1 | 4.90 |
| | | 8 Ga. | .164 | 13.672 | 24 | 63.6 | 3.67 | 3.58 | 146.8 | 7.13 | 170.7 | 24.4 | 4.89 |
| | | 6 Ga. | .194 | 13.612 | 29 | 63.1 | 3.67 | 3.56 | 145.5 | 8.41 | 200.6 | 28.7 | 4.88 |
| | | API | .210 | 13.580 | 31 | 62.8 | 3.67 | 3.55 | 144.8 | 9.10 | 216.2 | 30.9 | 4.87 |
| | | API | .219 | 13.562 | 32 | 62.6 | 3.67 | 3.55 | 144.5 | 9.48 | 225.1 | 32.2 | 4.87 |
| | | 3 Ga. | .239 | 13.522 | 35 | 62.3 | 3.67 | 3.54 | 143.6 | 10.33 | 244.9 | 35.0 | 4.87 |
| | | 10 | .250 | 13.500 | 37 | 62.1 | 3.67 | 3.54 | 143.0 | 10.82 | 256.0 | 36.6 | 4.86 |
| | | API | .281 | 13.438 | 41 | 61.5 | 3.67 | 3.52 | 141.8 | 12.11 | 285.2 | 40.7 | 4.85 |
| | | 20 | .312 | 13.375 | 46 | 60.8 | 3.67 | 3.50 | 140.5 | 13.44 | 314.9 | 45.0 | 4.84 |
| | | API | .344 | 13.312 | 50 | 60.3 | 3.67 | 3.48 | 139.2 | 14.76 | 344.3 | 49.2 | 4.83 |
| | | Std. | .375 | 13.250 | 55 | 59.7 | 3.67 | 3.47 | 137.9 | 16.05 | 372.8 | 53.2 | 4.82 |
| | | 40 | .438 | 13.124 | 63 | 58.5 | 3.67 | 3.44 | 135.3 | 18.66 | 429.6 | 61.4 | 4.80 |
| | | X-Stg. | .500 | 13.000 | 72 | 57.4 | 3.67 | 3.40 | 132.7 | 21.21 | 483.8 | 69.1 | 4.78 |
| | | -- | .594 | 12.812 | 85 | 55.9 | 3.67 | 3.35 | 129.0 | 24.98 | 562.4 | 80.3 | 4.74 |
| | | -- | .625 | 12.750 | 89 | 55.3 | 3.67 | 3.34 | 127.7 | 26.26 | 588.5 | 84.1 | 4.73 |
| | | 80 | .750 | 12.500 | 107 | 51.2 | 3.67 | 3.27 | 122.7 | 31.22 | 687.5 | 98.2 | 4.69 |
| | | -- | .875 | 12.250 | 123 | 51.1 | 3.67 | 3.21 | 117.9 | 36.08 | 780.1 | 111.4 | 4.65 |
| | | 100 | .938 | 12.124 | 131 | 50.0 | 3.67 | 3.17 | 115.5 | 38.47 | 820.5 | 117.2 | 4.63 |
| | | -- | 1.000 | 12.000 | 139 | 49.0 | 3.67 | 3.14 | 113.1 | 40.84 | 868.0 | 124.0 | 4.61 |
| | | 120 | 1.094 | 11.812 | 151 | 47.5 | 3.67 | 3.09 | 109.6 | 44.32 | 929.8 | 132.8 | 4.58 |
| | | -- | 1.125 | 11.750 | 155 | 47.0 | 3.67 | 3.08 | 108.4 | 45.50 | 950.3 | 135.8 | 4.57 |
| | | 140 | 1.250 | 11.500 | 171 | 45.0 | 3.67 | 3.01 | 103.9 | 50.07 | 1027.5 | 146.8 | 4.53 |
| | | -- | 1.375 | 11.250 | 186 | 43.1 | 3.67 | 2.94 | 99.4 | 54.54 | 1099.5 | 157.1 | 4.49 |
| | | 160 | 1.406 | 11.188 | 190 | 42.6 | 3.67 | 2.93 | 98.3 | 55.63 | 1116.9 | 159.6 | 4.48 |
| -- | 1.500 | 11.000 | 200 | 41.2 | 3.67 | 2.88 | 95.0 | 58.90 | 1166.5 | 166.6 | 4.45 | | |
| 16 | 16.000 | 10 Ga. | .134 | 15.732 | 23 | 84.3 | 4.19 | 4.12 | 194.4 | 6.68 | 210 | 26.3 | 5.61 |
| | | 8 Ga. | .164 | 15.672 | 28 | 83.6 | 4.19 | 4.10 | 192.9 | 8.16 | 256 | 32.0 | 5.60 |
| | | -- | .188 | 15.624 | 32 | 83.3 | 4.19 | 4.09 | 192.0 | 9.39 | 294 | 36.7 | 5.59 |
| | | 6 Ga. | .194 | 15.612 | 33 | 83.0 | 4.19 | 4.09 | 191.4 | 9.63 | 301 | 37.6 | 5.59 |
| | | API | .219 | 15.562 | 37 | 82.5 | 4.19 | 4.07 | 190.2 | 10.86 | 338 | 42.3 | 5.58 |
| | | 3 Ga. | .239 | 15.522 | 40 | 82.0 | 4.19 | 4.06 | 189.2 | 11.83 | 368 | 45.9 | 5.57 |
| | | 10 | .250 | 15.500 | 42 | 82.1 | 4.19 | 4.06 | 189.0 | 12.40 | 385 | 48.1 | 5.57 |
| | | API | .281 | 15.438 | 47 | 81.2 | 4.19 | 4.04 | 187.0 | 13.90 | 430 | 53.8 | 5.56 |
| | | 20 | .312 | 15.375 | 52 | 80.1 | 4.19 | 4.03 | 185.6 | 15.40 | 474 | 59.2 | 5.55 |
| | | API | .344 | 15.312 | 57 | 80.0 | 4.19 | 4.01 | 184.1 | 16.94 | 519 | 64.9 | 5.54 |
| | | Std. | .375 | 15.250 | 63 | 79.1 | 4.19 | 4.00 | 182.6 | 18.41 | 562 | 70.3 | 5.53 |
| | | API | .438 | 15.124 | 73 | 78.2 | 4.19 | 3.96 | 180.0 | 21.42 | 650 | 81.2 | 5.51 |
| | | X-Stg. | .500 | 15.000 | 83 | 76.5 | 4.19 | 3.93 | 176.7 | 24.35 | 732 | 91.5 | 5.48 |
| | | -- | .625 | 14.750 | 103 | 74.1 | 4.19 | 3.86 | 170.9 | 30.19 | 893 | 111.7 | 5.44 |
| | | 60 | .656 | 14.688 | 108 | 73.4 | 4.19 | 3.85 | 169.4 | 31.62 | 933 | 116.6 | 5.43 |
| | | -- | .750 | 14.500 | 122 | 71.5 | 4.19 | 3.80 | 165.1 | 35.93 | 1047 | 130.9 | 5.40 |
| | | 80 | .844 | 14.312 | 137 | 69.7 | 4.19 | 3.75 | 160.9 | 40.14 | 1157 | 144.6 | 5.37 |
| | | -- | .875 | 14.250 | 141 | 69.1 | 4.19 | 3.73 | 159.5 | 41.58 | 1192 | 149.0 | 5.35 |
| | | -- | 1.000 | 14.000 | 160 | 66.7 | 4.19 | 3.66 | 153.9 | 47.12 | 1331 | 166.4 | 5.31 |
| | | 100 | 1.031 | 13.938 | 165 | 66.0 | 4.19 | 3.65 | 152.6 | 48.49 | 1366 | 170.7 | 5.30 |
| | | -- | 1.125 | 13.750 | 179 | 64.4 | 4.19 | 3.60 | 148.5 | 52.57 | 1463 | 182.9 | 5.27 |
| | | 120 | 1.219 | 13.562 | 193 | 62.6 | 4.19 | 3.55 | 144.5 | 56.56 | 1556 | 194.5 | 5.24 |
| | | -- | 1.250 | 13.500 | 197 | 62.1 | 4.19 | 3.53 | 143.1 | 57.92 | 1586 | 198.3 | 5.23 |
| | | -- | 1.375 | 13.250 | 215 | 59.8 | 4.19 | 3.47 | 137.9 | 63.17 | 1704 | 213.0 | 5.19 |
| 140 | 1.438 | 13.124 | 224 | 58.6 | 4.19 | 3.44 | 135.3 | 65.79 | 1761 | 220.1 | 5.17 | | |
| -- | 1.500 | 13.000 | 232 | 57.4 | 4.19 | 3.40 | 132.7 | 68.33 | 1816 | 227.0 | 5.15 | | |
| 160 | 1.594 | 12.812 | 245 | 55.9 | 4.19 | 3.35 | 129.0 | 72.10 | 1893 | 236.6 | 5.12 | | |

D-16
(Continued). Properties of Pipe

| Nominal | | Designation | Wall Thickness | Inside Diam. d | Weight per Foot | Wt. of Water per Ft. of Pipe | Sq. Ft. Outside Surface per Ft. | Sq. Ft. Inside Surface per Ft. | Transverse Area in. ² | Area of Metal in. ² | Moment of Inertia in. ⁴ | Section Modulus in. ³ | Radius of Gyration in. |
|-----------|-----------------|-------------|----------------|----------------|-----------------|------------------------------|---------------------------------|--------------------------------|----------------------------------|--------------------------------|------------------------------------|----------------------------------|------------------------|
| Pipe Size | Outside Diam. D | | | | | | | | | | | | |
| 18 | 18.000 | 10 Ga. | .134 | 17.732 | 26 | 107.1 | 4.71 | 4.64 | 246.9 | 7.52 | 300 | 33.4 | 6.32 |
| | | 8 Ga. | .164 | 17.672 | 31 | 106.3 | 4.71 | 4.63 | 245.3 | 9.19 | 366 | 40.6 | 6.31 |
| | | 6 Ga. | .194 | 17.612 | 37 | 105.6 | 4.71 | 4.61 | 243.6 | 10.85 | 430 | 47.8 | 6.29 |
| | | 3 Ga. | .239 | 17.522 | 45 | 104.5 | 4.71 | 4.59 | 241.1 | 13.34 | 526 | 58.4 | 6.28 |
| | | 10 | .250 | 17.500 | 47 | 104.6 | 4.71 | 4.58 | 241.0 | 13.96 | 550 | 61.1 | 6.28 |
| | | API | .281 | 17.438 | 49 | 104.0 | 4.71 | 4.56 | 240.0 | 14.49 | 570 | 63.4 | 6.27 |
| | | 20 | .312 | 17.375 | 59 | 102.5 | 4.71 | 4.55 | 237.1 | 17.36 | 679 | 75.5 | 6.25 |
| | | API | .344 | 17.312 | 65 | 102.0 | 4.71 | 4.53 | 235.4 | 19.08 | 744 | 82.6 | 6.24 |
| | | Std. | .375 | 17.250 | 71 | 101.2 | 4.71 | 4.51 | 233.7 | 20.76 | 807 | 89.6 | 6.23 |
| | | API | .406 | 17.188 | 76 | 100.6 | 4.71 | 4.50 | 232.0 | 22.44 | 869 | 96.6 | 6.22 |
| | | 30 | .438 | 17.124 | 82 | 99.5 | 4.71 | 4.48 | 229.5 | 24.95 | 963 | 107.0 | 6.21 |
| | | X-Stg. | .500 | 17.000 | 93 | 98.2 | 4.71 | 4.45 | 227.0 | 27.49 | 1053 | 117.0 | 6.19 |
| | | 40 | .562 | 16.876 | 105 | 97.2 | 4.71 | 4.42 | 224.0 | 30.85 | 1177 | 130.9 | 6.17 |
| | | -- | .625 | 16.750 | 116 | 95.8 | 4.71 | 4.39 | 220.5 | 34.15 | 1290 | 143.2 | 6.14 |
| | | 60 | .750 | 16.500 | 138 | 92.5 | 4.71 | 4.32 | 213.8 | 40.64 | 1515 | 168.3 | 6.10 |
| | | -- | .875 | 16.250 | 160 | 89.9 | 4.71 | 4.25 | 207.4 | 47.07 | 1730 | 192.3 | 6.06 |
| | | 80 | .938 | 16.124 | 171 | 88.5 | 4.71 | 4.22 | 204.2 | 50.23 | 1834 | 203.8 | 6.04 |
| | | -- | 1.000 | 16.000 | 182 | 87.2 | 4.71 | 4.19 | 201.1 | 53.41 | 1935 | 215.0 | 6.02 |
| | | -- | 1.125 | 15.750 | 203 | 84.5 | 4.71 | 4.12 | 194.8 | 59.64 | 2133 | 237.0 | 5.98 |
| | | 100 | 1.156 | 15.688 | 208 | 83.7 | 4.71 | 4.11 | 193.3 | 61.18 | 2182 | 242.3 | 5.97 |
| -- | 1.250 | 15.500 | 224 | 81.8 | 4.71 | 4.06 | 188.7 | 65.78 | 2319 | 257.7 | 5.94 | | |
| 120 | 1.375 | 15.250 | 244 | 79.2 | 4.71 | 3.99 | 182.7 | 71.82 | 2498 | 277.5 | 5.90 | | |
| -- | 1.500 | 15.000 | 265 | 76.6 | 4.71 | 3.93 | 176.7 | 77.75 | 2668 | 296.5 | 5.86 | | |
| 140 | 1.562 | 14.876 | 275 | 75.3 | 4.71 | 3.89 | 173.8 | 80.66 | 2750 | 305.5 | 5.84 | | |
| 160 | 1.781 | 14.438 | 309 | 71.0 | 4.71 | 3.78 | 163.7 | 90.75 | 3020 | 335.5 | 5.77 | | |
| 20 | 20.000 | 10 Ga. | .134 | 19.732 | 28 | 132.6 | 5.24 | 5.17 | 305.8 | 8.36 | 413 | 41.3 | 7.02 |
| | | 8 Ga. | .164 | 19.672 | 35 | 131.8 | 5.24 | 5.15 | 303.9 | 10.22 | 503 | 50.3 | 7.01 |
| | | 6 Ga. | .194 | 19.612 | 41 | 131.0 | 5.24 | 5.13 | 302.1 | 12.07 | 592 | 59.2 | 7.00 |
| | | 3 Ga. | .239 | 19.522 | 50 | 129.8 | 5.24 | 5.11 | 299.3 | 14.84 | 725 | 72.5 | 6.99 |
| | | 10 | .250 | 19.500 | 53 | 130.0 | 5.24 | 5.11 | 299.0 | 15.52 | 759 | 75.9 | 6.98 |
| | | API | .281 | 19.438 | 59 | 128.6 | 5.24 | 5.09 | 296.8 | 17.41 | 846 | 84.6 | 6.97 |
| | | API | .312 | 19.374 | 66 | 128.1 | 5.24 | 5.08 | 295.0 | 19.36 | 937 | 93.7 | 6.95 |
| | | API | .344 | 19.312 | 72 | 127.0 | 5.24 | 5.06 | 292.9 | 21.24 | 1026 | 102.6 | 6.95 |
| | | Std. | .375 | 19.250 | 79 | 126.0 | 5.24 | 5.04 | 291.1 | 23.12 | 1113 | 111.3 | 6.94 |
| | | API | .406 | 19.188 | 85 | 125.4 | 5.24 | 5.02 | 289.2 | 24.99 | 1200 | 120.0 | 6.93 |
| | | API | .438 | 19.124 | 92 | 125.1 | 5.24 | 5.01 | 288.0 | 26.95 | 1290 | 129.0 | 6.92 |
| | | X-Stg. | .500 | 19.000 | 105 | 122.8 | 5.24 | 4.97 | 283.5 | 30.63 | 1457 | 145.7 | 6.90 |
| | | 40 | .594 | 18.812 | 123 | 120.4 | 5.24 | 4.93 | 278.0 | 36.15 | 1704 | 170.4 | 6.86 |
| | | -- | .625 | 18.750 | 129 | 119.5 | 5.24 | 4.91 | 276.1 | 38.04 | 1787 | 178.7 | 6.85 |
| | | 60 | .812 | 18.376 | 167 | 114.9 | 5.24 | 4.81 | 265.2 | 48.95 | 2257 | 225.7 | 6.79 |
| | | -- | .875 | 18.250 | 179 | 113.2 | 5.24 | 4.78 | 261.6 | 52.57 | 2409 | 240.9 | 6.77 |
| | | -- | 1.000 | 18.000 | 203 | 110.3 | 5.24 | 4.71 | 254.5 | 59.69 | 2702 | 270.2 | 6.73 |
| | | 80 | 1.031 | 17.938 | 209 | 109.4 | 5.24 | 4.80 | 252.7 | 61.44 | 2771 | 277.1 | 6.72 |
| | | -- | 1.125 | 17.750 | 227 | 107.3 | 5.24 | 4.65 | 247.4 | 66.71 | 2981 | 298.1 | 6.68 |
| | | -- | 1.250 | 17.500 | 250 | 104.3 | 5.24 | 4.58 | 240.5 | 73.63 | 3249 | 324.9 | 6.64 |
| 100 | 1.281 | 17.438 | 256 | 103.4 | 5.24 | 4.56 | 238.8 | 75.34 | 3317 | 331.7 | 6.63 | | |
| -- | 1.375 | 17.250 | 274 | 101.3 | 5.24 | 4.52 | 233.7 | 80.45 | 3508 | 350.8 | 6.60 | | |
| 120 | 1.500 | 17.000 | 297 | 98.3 | 5.24 | 4.45 | 227.0 | 87.18 | 3755 | 375.5 | 6.56 | | |
| 140 | 1.750 | 16.500 | 342 | 92.6 | 5.24 | 4.32 | 213.8 | 100.33 | 4217 | 421.7 | 6.48 | | |
| 160 | 1.969 | 16.062 | 379 | 87.9 | 5.24 | 4.21 | 202.7 | 111.49 | 4586 | 458.6 | 6.41 | | |

904 APPENDIX D

D-16
(Continued). Properties of Pipe

| Nominal | | Designation | Wall Thickness | Inside Diam. d | Weight per Foot | Wt. of Water per Ft. of Pipe | Sq. Ft. Outside Surface per Ft. | Sq. Ft. Inside Surface per Ft. | Transverse Area in. ² | Area of Metal in. ² | Moment of Inertia in. ⁴ | Section Modulus in. ³ | Radius of Gyration in. | | |
|-----------|-----------------|-------------|----------------|----------------|-----------------|------------------------------|---------------------------------|--------------------------------|----------------------------------|--------------------------------|------------------------------------|----------------------------------|------------------------|------|------|
| Pipe Size | Outside Diam. D | | | | | | | | | | | | | | |
| 22 | 22.000 | 8 Ga. | .164 | 21.672 | 38 | 159.9 | 5.76 | 5.67 | 368.9 | 11.25 | 671 | 61.0 | 7.72 | | |
| | | 6 Ga. | .194 | 21.612 | 45 | 159.0 | 5.76 | 5.66 | 366.8 | 13.29 | 790 | 71.8 | 7.71 | | |
| | | 3 Ga. | .239 | 21.522 | 56 | 157.7 | 5.76 | 5.63 | 363.8 | 16.34 | 967 | 87.9 | 7.69 | | |
| | | API | .250 | 21.500 | 58 | 157.4 | 5.76 | 5.63 | 363.1 | 17.18 | 1010 | 91.8 | 7.69 | | |
| | | API | .281 | 21.438 | 65 | 156.5 | 5.76 | 5.61 | 361.0 | 19.17 | 1131 | 102.8 | 7.68 | | |
| | | API | .312 | 21.376 | 72 | 155.6 | 5.76 | 5.60 | 358.9 | 21.26 | 1250 | 113.6 | 7.67 | | |
| | | API | .344 | 21.312 | 80 | 154.7 | 5.76 | 5.58 | 356.7 | 23.40 | 1373 | 124.8 | 7.66 | | |
| | | API | .375 | 21.250 | 87 | 153.7 | 5.76 | 5.56 | 354.7 | 25.48 | 1490 | 135.4 | 7.65 | | |
| | | API | .406 | 21.188 | 94 | 152.9 | 5.76 | 5.55 | 352.6 | 27.54 | 1607 | 146.1 | 7.64 | | |
| | | API | .438 | 21.124 | 101 | 151.9 | 5.76 | 5.53 | 350.5 | 29.67 | 1725 | 156.8 | 7.62 | | |
| | | API | .500 | 21.000 | 115 | 150.2 | 5.76 | 5.50 | 346.4 | 33.77 | 1953 | 177.5 | 7.61 | | |
| | | -- | .625 | 20.750 | 143 | 146.6 | 5.76 | 5.43 | 338.2 | 41.97 | 2400 | 218.2 | 7.56 | | |
| | | -- | .750 | 20.500 | 170 | 143.1 | 5.76 | 5.37 | 330.1 | 50.07 | 2829 | 257.2 | 7.52 | | |
| | | -- | .875 | 20.250 | 198 | 139.6 | 5.76 | 5.30 | 322.1 | 58.07 | 3245 | 295.0 | 7.47 | | |
| | | -- | 1.000 | 20.000 | 224 | 136.2 | 5.76 | 5.24 | 314.2 | 65.97 | 3645 | 331.4 | 7.43 | | |
| | | -- | 1.125 | 19.750 | 251 | 132.8 | 5.76 | 5.17 | 306.4 | 73.78 | 4029 | 366.3 | 7.39 | | |
| | | -- | 1.250 | 19.500 | 277 | 129.5 | 5.76 | 5.10 | 298.6 | 81.48 | 4400 | 400.0 | 7.35 | | |
| | | -- | 1.375 | 19.250 | 303 | 126.2 | 5.76 | 5.04 | 291.0 | 89.09 | 4758 | 432.6 | 7.31 | | |
| | | -- | 1.500 | 19.000 | 329 | 122.9 | 5.76 | 4.97 | 283.5 | 96.60 | 5103 | 463.9 | 7.27 | | |
| | | 24 | 24.000 | 8 Ga. | .164 | 23.672 | 42 | 190.8 | 6.28 | 6.20 | 440.1 | 12.28 | 872 | 72.7 | 8.43 |
| | | | | 6 Ga. | .194 | 23.612 | 49 | 189.8 | 6.28 | 6.18 | 437.9 | 14.51 | 1028 | 85.7 | 8.42 |
| 3 Ga. | .239 | | | 23.522 | 61 | 188.4 | 6.28 | 6.16 | 434.5 | 17.84 | 1260 | 105.0 | 8.40 | | |
| 10 | .250 | | | 23.500 | 63 | 189.0 | 6.28 | 6.15 | 435.0 | 18.67 | 1320 | 110.0 | 8.40 | | |
| API | .281 | | | 23.438 | 71 | 187.0 | 6.28 | 6.14 | 431.5 | 20.94 | 1472 | 122.7 | 8.38 | | |
| API | .312 | | | 23.376 | 79 | 186.9 | 6.28 | 6.12 | 430.0 | 23.20 | 1630 | 136.0 | 8.38 | | |
| API | .344 | | | 23.312 | 87 | 185.0 | 6.28 | 6.10 | 426.8 | 25.57 | 1789 | 149.1 | 8.36 | | |
| Std. | .375 | | | 23.250 | 95 | 183.8 | 6.28 | 6.09 | 424.6 | 27.83 | 1942 | 161.9 | 8.35 | | |
| API | .406 | | | 23.188 | 102 | 183.1 | 6.28 | 6.07 | 422.3 | 30.09 | 2095 | 174.6 | 8.34 | | |
| API | .438 | | | 23.124 | 110 | 182.1 | 6.28 | 6.05 | 420.0 | 32.42 | 2252 | 187.7 | 8.33 | | |
| X-Stg. | .500 | | | 23.000 | 125 | 181.0 | 6.28 | 6.02 | 416.0 | 36.90 | 2550 | 213.0 | 8.31 | | |
| 30 | .562 | | | 22.876 | 141 | 178.5 | 6.28 | 5.99 | 411.0 | 41.40 | 2840 | 237.0 | 8.28 | | |
| -- | .625 | | | 22.750 | 156 | 175.9 | 6.28 | 5.96 | 406.5 | 45.90 | 3137 | 261.4 | 8.27 | | |
| 40 | .688 | | | 22.624 | 171 | 174.2 | 6.28 | 5.92 | 402.1 | 50.30 | 3422 | 285.2 | 8.25 | | |
| -- | .750 | | | 22.500 | 186 | 172.1 | 6.28 | 5.89 | 397.6 | 54.78 | 3705 | 308.8 | 8.22 | | |
| -- | .875 | | | 22.250 | 216 | 168.6 | 6.28 | 5.82 | 388.8 | 63.57 | 4257 | 354.7 | 8.18 | | |
| 60 | .969 | | | 22.062 | 238 | 165.8 | 6.28 | 5.78 | 382.3 | 70.04 | 4652 | 387.7 | 8.15 | | |
| -- | 1.000 | | | 22.000 | 246 | 164.8 | 6.28 | 5.76 | 380.1 | 72.26 | 4788 | 399.0 | 8.14 | | |
| -- | 1.125 | | | 21.750 | 275 | 161.1 | 6.28 | 5.69 | 371.5 | 80.85 | 5302 | 441.8 | 8.10 | | |
| 80 | 1.219 | | | 21.562 | 297 | 158.2 | 6.28 | 5.65 | 365.2 | 87.17 | 5673 | 472.8 | 8.07 | | |
| -- | 1.250 | | | 21.500 | 304 | 157.4 | 6.28 | 5.63 | 363.1 | 89.34 | 5797 | 483.0 | 8.05 | | |
| -- | 1.375 | 21.250 | 332 | 153.8 | 6.28 | 5.56 | 354.7 | 97.73 | 6275 | 522.9 | 8.01 | | | | |
| -- | 1.500 | 21.000 | 361 | 150.2 | 6.28 | 5.50 | 346.4 | 106.03 | 6740 | 561.7 | 7.97 | | | | |
| 100 | 1.531 | 20.938 | 367 | 149.3 | 6.28 | 5.48 | 344.3 | 108.07 | 6847 | 570.6 | 7.96 | | | | |
| 120 | 1.812 | 20.376 | 429 | 141.4 | 6.28 | 5.33 | 326.1 | 126.30 | 7823 | 651.9 | 7.87 | | | | |
| 140 | 2.062 | 19.876 | 484 | 134.4 | 6.28 | 5.20 | 310.3 | 142.10 | 8627 | 718.9 | 7.79 | | | | |
| 160 | 2.344 | 19.312 | 542 | 127.0 | 6.28 | 5.06 | 293.1 | 159.40 | 9457 | 788.1 | 7.70 | | | | |
| 26 | 26.000 | 8 Ga. | .164 | 25.672 | 45 | 224.4 | 6.81 | 6.72 | 517.6 | 13.31 | 1111 | 85.4 | 9.13 | | |
| | | 6 Ga. | .194 | 25.612 | 54 | 223.4 | 6.81 | 6.70 | 515.2 | 15.73 | 1310 | 100.7 | 9.12 | | |
| | | 3 Ga. | .239 | 25.522 | 66 | 221.8 | 6.81 | 6.68 | 511.6 | 19.34 | 1605 | 123.4 | 9.11 | | |
| | | API | .250 | 25.500 | 67 | 221.4 | 6.81 | 6.68 | 510.7 | 19.85 | 1646 | 126.6 | 9.10 | | |
| | | API | .281 | 25.438 | 77 | 220.3 | 6.81 | 6.66 | 508.2 | 22.70 | 1877 | 144.4 | 9.09 | | |
| API | .312 | 25.376 | 84 | 219.2 | 6.81 | 6.64 | 505.8 | 25.18 | 2076 | 159.7 | 9.08 | | | | |

D-16 (Continued). Properties of Pipe

| Nominal | | Designation | Wall Thickness | Inside Diam. | Weight per Foot | Wt. of Water per Ft. of Pipe | Sq. Ft. Outside Surface per Ft. | Sq. Ft. Inside Surface per Ft. | Transverse Area in. ² | Area of Metal in. ² | Moment of Inertia in. ⁴ | Section Modulus in. ³ | Radius of Gyration in. | | |
|-----------|-----------------|-------------|----------------|--------------|-----------------|------------------------------|---------------------------------|--------------------------------|----------------------------------|--------------------------------|------------------------------------|----------------------------------|------------------------|-------|-------|
| Pipe Size | Outside Diam. D | | | | | | | | | | | | | | |
| 26 cont. | 26.000 | API | .344 | 25.312 | 94 | 218.2 | 6.81 | 6.63 | 503.2 | 27.73 | 2280 | 175.4 | 9.07 | | |
| | | API | .375 | 25.250 | 103 | 217.1 | 6.81 | 6.61 | 500.7 | 30.19 | 2478 | 190.6 | 9.06 | | |
| | | API | .406 | 25.188 | 111 | 216.0 | 6.81 | 6.59 | 498.3 | 32.64 | 2673 | 205.6 | 9.05 | | |
| | | API | .438 | 25.124 | 120 | 214.9 | 6.81 | 6.58 | 495.8 | 35.17 | 2874 | 221.1 | 9.04 | | |
| | | API | .500 | 25.000 | 136 | 212.8 | 6.81 | 6.54 | 490.9 | 40.06 | 3259 | 250.7 | 9.02 | | |
| | | -- | .625 | 24.750 | 169 | 208.6 | 6.81 | 6.48 | 481.1 | 49.82 | 4013 | 308.7 | 8.98 | | |
| | | -- | .750 | 24.500 | 202 | 204.4 | 6.81 | 6.41 | 471.4 | 59.49 | 4744 | 364.9 | 8.93 | | |
| | | -- | .875 | 24.250 | 235 | 200.2 | 6.81 | 6.35 | 461.9 | 69.07 | 5458 | 419.9 | 8.89 | | |
| | | -- | 1.000 | 24.000 | 267 | 196.1 | 6.81 | 6.28 | 452.4 | 78.54 | 6149 | 473.0 | 8.85 | | |
| | | -- | 1.125 | 23.750 | 299 | 192.1 | 6.81 | 6.22 | 443.0 | 87.91 | 6813 | 524.1 | 8.80 | | |
| | | -- | 1.375 | 23.250 | 362 | 184.1 | 6.81 | 6.09 | 424.6 | 106.37 | 8088 | 622.2 | 8.72 | | |
| | | -- | 1.500 | 23.000 | 393 | 180.1 | 6.81 | 6.02 | 415.5 | 115.45 | 8695 | 668.8 | 8.68 | | |
| | | 30 | 30.000 | 8 Ga. | .164 | 29.672 | 52 | 299.9 | 7.85 | 7.77 | 691.4 | 15.37 | 1711 | 114.0 | 10.55 |
| | | | | 6 Ga. | .194 | 29.612 | 62 | 298.6 | 7.85 | 7.75 | 688.6 | 18.17 | 2017 | 134.4 | 10.53 |
| | | | | 3 Ga. | .239 | 29.522 | 76 | 296.7 | 7.85 | 7.73 | 684.4 | 22.35 | 2474 | 165.0 | 10.52 |
| API | .250 | | | 29.500 | 79 | 296.3 | 7.85 | 7.72 | 683.4 | 23.37 | 2585 | 172.3 | 10.52 | | |
| API | .281 | | | 29.438 | 89 | 295.1 | 7.85 | 7.70 | 680.5 | 26.24 | 2897 | 193.1 | 10.51 | | |
| 10 | .312 | | | 29.376 | 99 | 293.7 | 7.85 | 7.69 | 677.8 | 29.19 | 3201 | 213.4 | 10.50 | | |
| API | .344 | | | 29.312 | 109 | 292.6 | 7.85 | 7.67 | 674.8 | 32.04 | 3524 | 235.0 | 10.49 | | |
| API | .375 | | | 29.250 | 119 | 291.2 | 7.85 | 7.66 | 672.0 | 34.90 | 3823 | 254.8 | 10.48 | | |
| API | .406 | | | 29.188 | 130 | 290.7 | 7.85 | 7.64 | 669.0 | 37.75 | 4132 | 275.5 | 10.46 | | |
| API | .438 | | | 29.124 | 138 | 288.8 | 7.85 | 7.62 | 666.1 | 40.68 | 4442 | 296.2 | 10.45 | | |
| 20 | .500 | | | 29.000 | 158 | 286.2 | 7.85 | 7.59 | 660.5 | 46.34 | 5033 | 335.5 | 10.43 | | |
| 30 | .625 | | | 28.750 | 196 | 281.3 | 7.85 | 7.53 | 649.2 | 57.68 | 6213 | 414.2 | 10.39 | | |
| -- | .750 | | | 28.500 | 234 | 276.6 | 7.85 | 7.46 | 637.9 | 68.92 | 7371 | 491.4 | 10.34 | | |
| -- | .875 | | | 28.250 | 272 | 271.8 | 7.85 | 7.39 | 620.7 | 80.06 | 8494 | 566.2 | 10.30 | | |
| -- | 1.000 | | | 28.000 | 310 | 267.0 | 7.85 | 7.33 | 615.7 | 91.11 | 9591 | 639.4 | 10.26 | | |
| -- | 1.125 | 27.750 | 347 | 262.2 | 7.85 | 7.26 | 604.7 | 102.05 | 10653 | 710.2 | 10.22 | | | | |
| -- | 1.250 | 27.500 | 384 | 257.5 | 7.85 | 7.20 | 593.9 | 112.90 | 11682 | 778.8 | 10.17 | | | | |
| -- | 1.375 | 27.250 | 421 | 252.9 | 7.85 | 7.13 | 583.1 | 123.65 | 12694 | 846.2 | 10.13 | | | | |
| -- | 1.500 | 27.000 | 457 | 248.2 | 7.85 | 7.07 | 572.5 | 134.30 | 13673 | 911.5 | 10.09 | | | | |
| 32 | 32.000 | API | .250 | 31.500 | 85 | 337.8 | 8.38 | 8.25 | 779.2 | 24.93 | 3141 | 196.3 | 11.22 | | |
| | | API | .281 | 31.438 | 95 | 336.5 | 8.38 | 8.23 | 776.2 | 28.04 | 3525 | 220.3 | 11.21 | | |
| | | API | .312 | 31.376 | 106 | 335.2 | 8.38 | 8.21 | 773.2 | 31.02 | 3891 | 243.2 | 11.20 | | |
| | | API | .344 | 31.312 | 116 | 333.8 | 8.38 | 8.20 | 770.0 | 34.24 | 4287 | 268.0 | 11.19 | | |
| | | API | .375 | 31.250 | 127 | 332.5 | 8.38 | 8.18 | 766.9 | 37.25 | 4656 | 291.0 | 11.18 | | |
| | | API | .406 | 31.188 | 137 | 331.2 | 8.38 | 8.16 | 764.0 | 40.29 | 5025 | 314.1 | 11.17 | | |
| | | API | .438 | 31.124 | 143 | 329.8 | 8.38 | 8.15 | 760.8 | 43.43 | 5407 | 337.9 | 11.16 | | |
| | | API | .500 | 31.000 | 168 | 327.2 | 8.38 | 8.11 | 754.7 | 49.48 | 6140 | 383.8 | 11.14 | | |
| | | -- | .625 | 30.750 | 209 | 321.9 | 8.38 | 8.05 | 742.5 | 61.59 | 7578 | 473.6 | 11.09 | | |
| | | -- | .750 | 30.500 | 250 | 316.7 | 8.38 | 7.98 | 730.5 | 73.63 | 8990 | 561.9 | 11.05 | | |
| | | -- | .875 | 30.250 | 291 | 311.5 | 8.38 | 7.92 | 718.6 | 85.53 | 10368 | 648.0 | 11.01 | | |
| | | -- | 1.000 | 30.000 | 331 | 306.4 | 8.38 | 7.85 | 706.8 | 97.38 | 11680 | 730.0 | 10.95 | | |
| | | -- | 1.125 | 29.750 | 371 | 301.3 | 8.38 | 7.79 | 695.0 | 109.0 | 13003 | 812.7 | 10.92 | | |
| | | -- | 1.250 | 29.500 | 410 | 296.3 | 8.38 | 7.72 | 680.5 | 120.7 | 14398 | 899.9 | 10.88 | | |
| | | -- | 1.375 | 29.250 | 450 | 291.2 | 8.38 | 7.66 | 671.9 | 132.2 | 15526 | 970.4 | 10.84 | | |
| -- | 1.500 | 29.000 | 489 | 286.3 | 8.38 | 7.59 | 660.5 | 143.7 | 16752 | 1047.0 | 10.80 | | | | |

906 APPENDIX D

D-16
(Continued). Properties of Pipe

| Nominal | | Design- ation | Wall Thick- ness | Inside Diam. d | Weight per Foot | Wt. of Water per Ft. of Pipe | Sq. Ft. Outside Surface per Ft. | Sq. Ft. Inside Surface per Ft. | Trans- verse Area in. ² | Area of Metal in. ² | Moment of Inertia in. ⁴ | Section Modulus in. ³ | Radius of Gyra- tion in. | | |
|--------------|-----------------------|------------------|------------------------|----------------------|-----------------------|---------------------------------------|--|---|---|---|---|--|-----------------------------------|-------|-------|
| Pipe Size | Outside Diam. D | | | | | | | | | | | | | | |
| 34 | 34.000 | API | .250 | 33.500 | 90 | 382.0 | 8.90 | 8.77 | 881.2 | 26.50 | 3773 | 221.9 | 11.93 | | |
| | | API | .281 | 33.438 | 101 | 380.7 | 8.90 | 8.75 | 878.2 | 29.77 | 4230 | 248.8 | 11.92 | | |
| | | API | .312 | 33.376 | 112 | 379.3 | 8.90 | 8.74 | 874.9 | 32.99 | 4680 | 275.3 | 11.91 | | |
| | | API | .344 | 33.312 | 124 | 377.8 | 8.90 | 8.72 | 871.6 | 36.36 | 5147 | 302.8 | 11.90 | | |
| | | API | .375 | 33.250 | 135 | 376.2 | 8.90 | 8.70 | 867.8 | 39.61 | 5597 | 329.2 | 11.89 | | |
| | | API | .406 | 33.188 | 146 | 375.0 | 8.90 | 8.69 | 865.0 | 42.88 | 6047 | 355.7 | 11.87 | | |
| | | API | .438 | 33.124 | 157 | 373.6 | 8.90 | 8.67 | 861.7 | 46.18 | 6501 | 382.4 | 11.86 | | |
| | | API | .500 | 33.000 | 179 | 370.8 | 8.90 | 8.64 | 856.3 | 52.62 | 7385 | 434.4 | 11.85 | | |
| | | -- | .625 | 32.750 | 223 | 365.0 | 8.90 | 8.57 | 841.9 | 65.53 | 9124 | 536.7 | 11.80 | | |
| | | -- | .750 | 32.500 | 266 | 359.5 | 8.90 | 8.51 | 829.3 | 78.34 | 10829 | 637.0 | 11.76 | | |
| | | -- | .875 | 32.250 | 308 | 354.1 | 8.90 | 8.44 | 816.8 | 90.66 | 12442 | 731.9 | 11.71 | | |
| | | -- | 1.000 | 32.000 | 353 | 348.6 | 8.90 | 8.38 | 804.2 | 103.6 | 14114 | 830.2 | 11.67 | | |
| | | -- | 1.125 | 31.750 | 395 | 343.2 | 8.90 | 8.31 | 791.6 | 116.1 | 15703 | 923.7 | 11.63 | | |
| | | -- | 1.250 | 31.500 | 437 | 337.8 | 8.90 | 8.25 | 779.2 | 128.5 | 17246 | 1014.5 | 11.58 | | |
| | | -- | 1.375 | 31.250 | 479 | 332.4 | 8.90 | 8.18 | 766.9 | 140.9 | 18770 | 1104.1 | 11.54 | | |
| | | -- | 1.500 | 31.000 | 521 | 327.2 | 8.90 | 8.11 | 754.7 | 153.1 | 20247 | 1191.0 | 11.50 | | |
| | | 36 | 36.000 | -- | .164 | 35.672 | 63 | 433.2 | 9.42 | 9.34 | 999.3 | 18.53 | 2975 | 165.3 | 12.67 |
| | | | | -- | .194 | 35.612 | 74 | 431.8 | 9.42 | 9.32 | 996.0 | 21.83 | 3499 | 194.4 | 12.66 |
| -- | .239 | | | 35.522 | 91 | 429.6 | 9.42 | 9.30 | 991.0 | 26.86 | 4293 | 238.5 | 12.64 | | |
| API | .250 | | | 35.500 | 96 | 429.1 | 9.42 | 9.29 | 989.7 | 28.11 | 4491 | 249.5 | 12.64 | | |
| API | .281 | | | 35.438 | 107 | 427.6 | 9.42 | 9.28 | 986.4 | 31.49 | 5023 | 279.1 | 12.63 | | |
| API | .312 | | | 35.376 | 119 | 426.1 | 9.42 | 9.26 | 982.9 | 34.95 | 5565 | 309.1 | 12.62 | | |
| API | .344 | | | 35.312 | 131 | 424.6 | 9.42 | 9.24 | 979.3 | 38.56 | 6127 | 340.4 | 12.60 | | |
| API | .375 | | | 35.250 | 143 | 423.1 | 9.42 | 9.23 | 975.8 | 42.01 | 6664 | 370.2 | 12.59 | | |
| API | .406 | | | 35.188 | 154 | 421.6 | 9.42 | 9.21 | 972.5 | 45.40 | 7191 | 399.5 | 12.58 | | |
| API | .438 | | | 35.124 | 166 | 420.1 | 9.42 | 9.19 | 968.9 | 48.93 | 7737 | 429.9 | 12.57 | | |
| API | .500 | | | 35.000 | 190 | 417.1 | 9.42 | 9.16 | 962.1 | 55.76 | 8785 | 488.1 | 12.55 | | |
| -- | .625 | | | 34.750 | 236 | 411.1 | 9.42 | 9.10 | 948.3 | 69.50 | 10872 | 604.0 | 12.51 | | |
| -- | .750 | | | 34.500 | 282 | 405.3 | 9.42 | 9.03 | 934.7 | 83.01 | 12898 | 716.5 | 12.46 | | |
| -- | .875 | | | 34.250 | 329 | 399.4 | 9.42 | 8.97 | 921.2 | 96.60 | 14906 | 828.1 | 12.42 | | |
| -- | 1.000 | | | 34.000 | 374 | 393.6 | 9.42 | 8.90 | 907.9 | 109.9 | 16851 | 936.2 | 12.38 | | |
| -- | 1.125 | | | 33.750 | 419 | 387.8 | 9.42 | 8.83 | 894.5 | 123.3 | 18766 | 1042.6 | 12.34 | | |
| -- | 1.250 | | | 33.500 | 464 | 382.1 | 9.42 | 8.77 | 881.3 | 136.5 | 20624 | 1145.8 | 12.29 | | |
| -- | 1.375 | | | 33.250 | 509 | 376.4 | 9.42 | 8.70 | 868.2 | 149.6 | 22451 | 1247.3 | 12.25 | | |
| -- | 1.500 | 33.000 | 553 | 370.8 | 9.42 | 8.64 | 855.3 | 162.6 | 24237 | 1346.5 | 12.21 | | | | |
| 42 | 42.000 | -- | .250 | 41.500 | 112 | 586.4 | 10.99 | 10.86 | 1352.6 | 32.82 | 7126 | 339.3 | 14.73 | | |
| | | -- | .375 | 41.250 | 167 | 579.3 | 10.99 | 10.80 | 1336.3 | 49.08 | 10627 | 506.1 | 14.71 | | |
| | | -- | .500 | 41.000 | 222 | 572.3 | 10.99 | 10.73 | 1320.2 | 65.18 | 14037 | 668.4 | 14.67 | | |
| | | -- | .625 | 40.750 | 276 | 565.4 | 10.99 | 10.67 | 1304.1 | 81.28 | 17373 | 827.3 | 14.62 | | |
| | | -- | .750 | 40.500 | 331 | 558.4 | 10.99 | 10.60 | 1288.2 | 97.23 | 20689 | 985.2 | 14.59 | | |
| | | -- | .875 | 40.250 | 385 | 551.6 | 10.99 | 10.54 | 1272.3 | 113.0 | 23896 | 1137.9 | 14.54 | | |
| | | -- | 1.000 | 40.000 | 438 | 544.8 | 10.99 | 10.47 | 1256.6 | 128.8 | 27080 | 1289.5 | 14.50 | | |
| | | -- | 1.125 | 39.750 | 492 | 537.9 | 10.99 | 10.41 | 1240.9 | 144.5 | 30193 | 1437.8 | 14.45 | | |
| | | -- | 1.250 | 39.500 | 544 | 531.2 | 10.99 | 10.34 | 1225.3 | 160.0 | 33233 | 1582.5 | 14.41 | | |
| | | -- | 1.375 | 39.250 | 597 | 524.4 | 10.99 | 10.27 | 1209.9 | 175.5 | 36240 | 1725.7 | 14.37 | | |
| | | -- | 1.500 | 39.000 | 649 | 517.9 | 10.99 | 10.21 | 1194.5 | 190.8 | 39181 | 1865.7 | 14.33 | | |

D-16 Equation of Pipes

The table below gives the number of pipes of one size required to equal in delivery other larger pipes of same length and under same conditions. The upper portion above the diagonal line of stars pertains to "standard" steam and gas pipes, while the lower portion is for pipes of the ACTUAL internal diameters given. The figures given in the table opposite the intersection of any two sizes is the number of the smaller-sized pipes required to equal one of the larger. Thus, it requires 29 standard 2-inch pipes to equal one standard 7-inch pipe.

STANDARD STEAM AND GAS PIPES

| Dia. | ½ | ¾ | 1 | 1½ | 2 | 2½ | 3 | 4 | 5 | 6 | 7 | 8 | 9 | 10 | 11 | 12 | 13 | 14 | 15 | 16 | 17 | Dia. |
|------|--------|-------|-------|-------|------|------|------|------|------|------|------|------|------|------|------|------|------|------|------|------|------|------|
| ½ | *** | 2.27 | 4.88 | 15.8 | 31.7 | 52.9 | 96.9 | 205 | 377 | 620 | 918 | 1292 | 1767 | 2488 | 3014 | 3786 | 4904 | 5927 | 7321 | 8535 | 9717 | ½ |
| ¾ | 2.60 | *** | 2.05 | 6.97 | 11.0 | 23.3 | 42.5 | 90.4 | 166 | 273 | 405 | 569 | 779 | 1096 | 1328 | 1668 | 2161 | 2615 | 3226 | 3761 | 4282 | ¾ |
| 1 | 7.55 | 2.90 | *** | 3.45 | 6.82 | 11.4 | 20.9 | 44.1 | 81.1 | 133 | 198 | 278 | 380 | 536 | 649 | 815 | 1070 | 1263 | 1576 | 1837 | 2092 | 1 |
| 1½ | 24.2 | 9.30 | 3.20 | *** | 1.26 | 3.34 | 6.13 | 13.0 | 23.8 | 39.2 | 58.1 | 81.7 | 112 | 157 | 190 | 239 | 310 | 375 | 463 | 539 | 614 | 1½ |
| 2 | 54.8 | 21.0 | 7.25 | 2.26 | *** | 1.67 | 3.06 | 6.47 | 11.9 | 19.6 | 29.0 | 40.8 | 55.8 | 78.5 | 95.1 | 119 | 155 | 187 | 231 | 269 | 307 | 2 |
| 2½ | 102 | 39.4 | 13.6 | 4.23 | 1.87 | *** | 1.83 | 3.87 | 7.12 | 11.7 | 17.4 | 24.4 | 33.4 | 47.0 | 56.9 | 71.5 | 92.6 | 112 | 138 | 161 | 184 | 2½ |
| 3 | 170 | 65.4 | 22.6 | 7.03 | 3.11 | 1.66 | *** | 2.12 | 3.89 | 6.39 | 9.48 | 13.3 | 20.9 | 23.7 | 31.2 | 39.1 | 50.6 | 61.1 | 75.5 | 88.0 | 100 | 3 |
| 4 | 376 | 144 | 49.8 | 15.5 | 6.87 | 3.67 | 2.21 | *** | 1.84 | 3.02 | 4.48 | 6.30 | 8.61 | 12.1 | 14.7 | 18.5 | 23.9 | 28.9 | 35.7 | 41.6 | 47.4 | 4 |
| 5 | 686 | 263 | 90.9 | 28.3 | 12.5 | 6.70 | 4.03 | 1.83 | *** | 1.65 | 2.44 | 3.43 | 4.69 | 6.60 | 8.00 | 10.0 | 13.0 | 15.7 | 19.4 | 22.6 | 25.8 | 5 |
| 6 | 1116 | 429 | 148 | 46.0 | 20.4 | 10.9 | 6.56 | 2.97 | 1.63 | *** | 1.48 | 2.09 | 2.85 | 4.02 | 4.86 | 6.11 | 7.91 | 9.56 | 11.8 | 13.8 | 15.6 | 6 |
| 7 | 1707 | 656 | 226 | 70.5 | 31.2 | 16.6 | 10.0 | 4.54 | 2.49 | 1.51 | *** | 1.41 | 1.93 | 2.71 | 3.28 | 4.12 | 5.34 | 6.45 | 7.97 | 9.31 | 10.6 | 7 |
| 8 | 2435 | 936 | 322 | 101 | 44.5 | 23.8 | 14.3 | 6.48 | 3.54 | 2.18 | 1.43 | *** | 1.35 | 1.93 | 2.33 | 2.92 | 3.79 | 4.57 | 5.67 | 6.60 | 7.52 | 8 |
| 9 | 3335 | 1281 | 440 | 137 | 60.8 | 32.5 | 19.5 | 8.85 | 4.85 | 2.98 | 1.95 | 1.37 | *** | 1.41 | 1.71 | 2.14 | 2.77 | 3.35 | 4.14 | 4.83 | 5.50 | 9 |
| 10 | 4393 | 1688 | 582 | 181 | 80.4 | 42.9 | 25.8 | 11.7 | 6.40 | 3.93 | 2.57 | 1.80 | 1.32 | *** | 1.21 | 1.52 | 1.97 | 2.38 | 2.94 | 3.43 | 3.91 | 10 |
| 11 | 5642 | 2168 | 747 | 233 | 103 | 55.1 | 33.1 | 15.0 | 8.22 | 5.05 | 3.31 | 2.32 | 1.70 | 1.28 | *** | 1.26 | 1.63 | 1.88 | 2.43 | 2.83 | 3.22 | 11 |
| 12 | 7087 | 2723 | 938 | 293 | 129 | 69.2 | 41.6 | 18.8 | 10.3 | 6.34 | 4.15 | 2.91 | 2.13 | 1.61 | 1.26 | *** | 1.30 | 1.57 | 1.93 | 2.26 | 2.58 | 12 |
| 13 | 8657 | 3226 | 1146 | 358 | 158 | 84.5 | 50.7 | 23.0 | 12.6 | 7.75 | 5.07 | 3.56 | 2.60 | 1.98 | 1.53 | 1.22 | *** | 1.21 | 1.49 | 1.74 | 1.98 | 13 |
| 14 | 10600 | 4070 | 1403 | 438 | 193 | 103 | 62.2 | 28.2 | 15.4 | 9.48 | 6.21 | 4.35 | 3.18 | 2.41 | 1.88 | 1.50 | 1.22 | *** | 1.24 | 1.44 | 1.64 | 14 |
| 15 | 12824 | 4927 | 1698 | 530 | 234 | 125 | 75.3 | 34.1 | 18.7 | 11.5 | 7.52 | 5.27 | 3.85 | 2.92 | 2.27 | 1.81 | 1.48 | 1.21 | *** | 1.17 | 1.35 | 15 |
| 16 | 14978 | 5758 | 1984 | 619 | 274 | 146 | 88.0 | 39.9 | 21.8 | 13.4 | 8.78 | 6.15 | 4.51 | 3.41 | 2.66 | 2.12 | 1.73 | 1.42 | 1.18 | *** | 1.14 | 16 |
| 17 | 17537 | 6738 | 2322 | 724 | 320 | 171 | 103 | 46.6 | 25.6 | 15.7 | 10.3 | 7.20 | 5.27 | 3.99 | 3.11 | 2.47 | 2.03 | 1.66 | 1.37 | 1.17 | *** | 17 |
| 18 | 20327 | 7810 | 2691 | 840 | 317 | 198 | 119 | 54.1 | 29.6 | 18.2 | 11.9 | 8.35 | 6.11 | 4.63 | 3.60 | 2.87 | 2.35 | 1.92 | 1.59 | 1.36 | 1.16 | 18 |
| 20 | 26676 | 10249 | 3532 | 1102 | 487 | 260 | 157 | 70.9 | 38.9 | 23.9 | 15.6 | 10.9 | 8.02 | 6.07 | 4.73 | 3.76 | 3.08 | 2.52 | 2.08 | 1.78 | 1.52 | 20 |
| 24 | 42624 | 16376 | 5644 | 1761 | 778 | 416 | 250 | 113 | 62.1 | 38.2 | 25.0 | 17.5 | 12.8 | 9.70 | 7.55 | 6.01 | 4.92 | 4.02 | 3.32 | 2.84 | 2.43 | 24 |
| 30 | 75453 | 28990 | 9990 | 3117 | 1378 | 736 | 443 | 201 | 110 | 67.6 | 44.2 | 31.0 | 22.7 | 17.2 | 13.4 | 10.7 | 8.72 | 7.14 | 5.88 | 5.03 | 4.30 | 30 |
| 36 | 120100 | 46143 | 15902 | 4961 | 2193 | 1172 | 705 | 319 | 175 | 108 | 70.4 | 49.3 | 36.1 | 27.3 | 21.3 | 16.9 | 13.9 | 11.3 | 9.37 | 8.01 | 6.85 | 36 |
| 42 | 177724 | 68282 | 23541 | 7341 | 3245 | 1734 | 1044 | 473 | 259 | 159 | 104 | 73.0 | 53.4 | 40.5 | 31.5 | 25.1 | 20.5 | 16.8 | 13.9 | 11.9 | 10.1 | 42 |
| 48 | 249351 | 95818 | 33020 | 10301 | 4554 | 2434 | 1465 | 663 | 363 | 223 | 146 | 102 | 75.0 | 56.8 | 44.2 | 35.2 | 28.8 | 23.5 | 19.4 | 16.6 | 14.2 | 48 |
| Dia. | ½ | ¾ | 1 | 1½ | 2 | 2½ | 3 | 4 | 5 | 6 | 7 | 8 | 9 | 10 | 11 | 12 | 13 | 14 | 15 | 16 | 17 | Dia. |

By permission, Buffalo Tank Div., Bethlehem Steel Corp.

D-18 (Continued). Circumferences and Areas of Circles (Advancing of eighths)

D-18 (Continued). Circumferences and Areas of Circles (Advancing of eighths)

Table with 8 columns: Dia., Circum., Area*, Circum., Area*, Dia., Circum., Area*. Contains numerical data for various circle diameters and their corresponding circumferences and areas.

*Approximate area, sufficiently accurate for practical purposes, including estimating.

*Approximate area, sufficiently accurate for practical purposes, including estimating.

D-18 (Continued). Circumferences and Areas of Circles (Advancing of eighths)

Table with 6 columns: Dia., Circum., Area*, Circum., Area*, Dia. It contains numerical data for various circle diameters, organized into numbered groups (1, 2, 3, 4, 5, 6, 7, 8, 9, 10).

*Approximate area, sufficiently accurate for practical purposes, including estimating.

D-18 (Continued). Circumferences and Areas of Circles (Advancing of eighths)

Table with 6 columns: Dia., Circum., Area*, Circum., Area*, Dia. It continues the numerical data from the previous table, organized into numbered groups (11, 12, 13, 14, 15, 16, 17, 18, 19, 20, 21, 22, 23, 24, 25, 26, 27, 28, 29).

*Approximate area, sufficiently accurate for practical purposes, including estimating.

D-18 (Continued). Circumferences and Areas of Circles (Advancing of eighths)

Table with 6 columns: Dia., Circum., Area*, Dia., Circum., Area*. Rows 86 1/4 to 99 1/4.

*Approximate area, sufficiently accurate for practical purposes, including estimating.

D-18 (Continued). Circumferences and Areas of Circles (Advancing of eighths)

Table with 6 columns: Dia., Circum., Area*, Dia., Circum., Area*. Rows 80 1/4 to 86 1/4.

*Approximate area, sufficiently accurate for practical purposes, including estimating.

D-18
(Continued). Circumferences and Areas of Circles
(Advancing of eighths)

| 105 | 106 | 107 | 108 | 109 | 110 | 111 |
|--|--|--|--|--|--|--|
| 1/4 1/2 3/4 1 1 1/8 1 1/4 1 1/2 1 3/4 2 2 1/8 2 1/4 2 1/2 2 3/4 3 3 1/8 3 1/4 3 1/2 3 3/4 4 4 1/8 4 1/4 4 1/2 4 3/4 5 5 1/8 5 1/4 5 1/2 5 3/4 6 6 1/8 6 1/4 6 1/2 6 3/4 7 7 1/8 7 1/4 7 1/2 7 3/4 8 8 1/8 8 1/4 8 1/2 8 3/4 9 9 1/8 9 1/4 9 1/2 9 3/4 10 | 1/4 1/2 3/4 1 1 1/8 1 1/4 1 1/2 1 3/4 2 2 1/8 2 1/4 2 1/2 2 3/4 3 3 1/8 3 1/4 3 1/2 3 3/4 4 4 1/8 4 1/4 4 1/2 4 3/4 5 5 1/8 5 1/4 5 1/2 5 3/4 6 6 1/8 6 1/4 6 1/2 6 3/4 7 7 1/8 7 1/4 7 1/2 7 3/4 8 8 1/8 8 1/4 8 1/2 8 3/4 9 9 1/8 9 1/4 9 1/2 9 3/4 10 | 1/4 1/2 3/4 1 1 1/8 1 1/4 1 1/2 1 3/4 2 2 1/8 2 1/4 2 1/2 2 3/4 3 3 1/8 3 1/4 3 1/2 3 3/4 4 4 1/8 4 1/4 4 1/2 4 3/4 5 5 1/8 5 1/4 5 1/2 5 3/4 6 6 1/8 6 1/4 6 1/2 6 3/4 7 7 1/8 7 1/4 7 1/2 7 3/4 8 8 1/8 8 1/4 8 1/2 8 3/4 9 9 1/8 9 1/4 9 1/2 9 3/4 10 | 1/4 1/2 3/4 1 1 1/8 1 1/4 1 1/2 1 3/4 2 2 1/8 2 1/4 2 1/2 2 3/4 3 3 1/8 3 1/4 3 1/2 3 3/4 4 4 1/8 4 1/4 4 1/2 4 3/4 5 5 1/8 5 1/4 5 1/2 5 3/4 6 6 1/8 6 1/4 6 1/2 6 3/4 7 7 1/8 7 1/4 7 1/2 7 3/4 8 8 1/8 8 1/4 8 1/2 8 3/4 9 9 1/8 9 1/4 9 1/2 9 3/4 10 | 1/4 1/2 3/4 1 1 1/8 1 1/4 1 1/2 1 3/4 2 2 1/8 2 1/4 2 1/2 2 3/4 3 3 1/8 3 1/4 3 1/2 3 3/4 4 4 1/8 4 1/4 4 1/2 4 3/4 5 5 1/8 5 1/4 5 1/2 5 3/4 6 6 1/8 6 1/4 6 1/2 6 3/4 7 7 1/8 7 1/4 7 1/2 7 3/4 8 8 1/8 8 1/4 8 1/2 8 3/4 9 9 1/8 9 1/4 9 1/2 9 3/4 10 | 1/4 1/2 3/4 1 1 1/8 1 1/4 1 1/2 1 3/4 2 2 1/8 2 1/4 2 1/2 2 3/4 3 3 1/8 3 1/4 3 1/2 3 3/4 4 4 1/8 4 1/4 4 1/2 4 3/4 5 5 1/8 5 1/4 5 1/2 5 3/4 6 6 1/8 6 1/4 6 1/2 6 3/4 7 7 1/8 7 1/4 7 1/2 7 3/4 8 8 1/8 8 1/4 8 1/2 8 3/4 9 9 1/8 9 1/4 9 1/2 9 3/4 10 | 1/4 1/2 3/4 1 1 1/8 1 1/4 1 1/2 1 3/4 2 2 1/8 2 1/4 2 1/2 2 3/4 3 3 1/8 3 1/4 3 1/2 3 3/4 4 4 1/8 4 1/4 4 1/2 4 3/4 5 5 1/8 5 1/4 5 1/2 5 3/4 6 6 1/8 6 1/4 6 1/2 6 3/4 7 7 1/8 7 1/4 7 1/2 7 3/4 8 8 1/8 8 1/4 8 1/2 8 3/4 9 9 1/8 9 1/4 9 1/2 9 3/4 10 |

*Approximate area, sufficiently accurate for practical purposes, including estimating.

*Approximate area, sufficiently accurate for practical purposes, including estimating.

D-18

(Continued). Circumferences and Areas of Circles (Advancing of eighths)

Table with columns: Dia., Circum., Area*, Circum., Area*, Dia., Circum., Area*, Circum., Area*, Dia., Circum., Area*, Circum., Area* for diameters 180-186.

*Approximate area, sufficiently accurate for practical purposes, including estimating.

D-18

(Continued). Circumferences and Areas of Circles (Advancing of eighths)

Table with columns: Dia., Circum., Area*, Circum., Area*, Dia., Circum., Area*, Circum., Area*, Dia., Circum., Area*, Circum., Area* for diameters 198-204.

*Approximate area, sufficiently accurate for practical purposes, including estimating.

D-19 (Continued). Capacities of Cylinders and Spheres

D-19 Capacities of Cylinders and Spheres

Table with 14 columns: Diam. in Feet, Cu. Ft. per Foot of Cylinder, Gallons per Foot of Cylinder, 42 Gallon Barrels per Foot of Cylinder, Sphere Surface in Sq. Ft., Sphere Volume in Cu. Ft., Diam. in Feet, Cu. Ft. per Foot of Cylinder, Gallons per Foot of Cylinder, 42 Gallon Barrels per Foot of Cylinder, Sphere Surface in Sq. Ft., Sphere Volume in Cu. Ft., Diam. in Feet, Cu. Ft. per Foot of Cylinder, Gallons per Foot of Cylinder, 42 Gallon Barrels per Foot of Cylinder, Sphere Surface in Sq. Ft., Sphere Volume in Cu. Ft.

By permission, Buffalo Tank Div., Bethlehem Steel Corp.

D-19 (Continued). Capacities of Cylinders and Spheres

D-19 (Continued). Capacities of Cylinders and Spheres

Table with 12 columns: Diam. in Feet, Cu. Ft. per Foot of Cylinder, Gallons per Foot of Cylinder, 42 Gallon Barrels per Foot of Cylinder, Sphere Surface in Sq. Ft., Sphere Volume in Cu. Ft., 42 Gallon Barrels per Foot of Cylinder, Cu. Ft. per Foot of Cylinder, Sphere Surface in Sq. Ft., Sphere Volume in Cu. Ft., 42 Gallon Barrels per Foot of Cylinder, Cu. Ft. per Foot of Cylinder. Rows 30-41.

D-19 (Continued). Capacities of Cylinders and Spheres

Table with 12 columns: Diam. in Feet, Cu Ft. in Foot of Cylinder, Gallons in Foot of Cylinder, Spheres Surface in Sq. Ft., Spheres Volume in Cu. Ft., 42 Gallon Barrels per Foot of Cylinder, Cu. Ft. in Foot of Cylinder, Gallons in Foot of Cylinder, Spheres Surface in Sq. Ft., Spheres Volume in Cu. Ft., 42 Gallon Barrels per Foot of Cylinder, Cu. Ft. in Foot of Cylinder, Gallons in Foot of Cylinder, Spheres Surface in Sq. Ft., Spheres Volume in Cu. Ft.

D-19
(Concluded). Capacities of Cylinders and Spheres

| Diam. in Feet | Cu. Ft. per Foot of Cylinder | Gallons per Foot of Cylinder | 42 Gallon Barrels per Foot of Cylinder | Sphere Surface in Sq. Ft. | Sphere Volume in Cu. Ft. | Diam. in Feet | Cu. Ft. per Foot of Cylinder | Gallons per Foot of Cylinder | 42 Gallon Barrels per Foot of Cylinder | Sphere Surface in Sq. Ft. | Sphere Volume in Cu. Ft. |
|---------------|------------------------------|------------------------------|--|---------------------------|--------------------------|---------------|------------------------------|------------------------------|--|---------------------------|--------------------------|
| 126 | 12469 | 93274 | 2220.8 | 49876 | 1047394 | 138 | 14957 | 111887 | 2664.0 | 59828 | 1376055 |
| 126 1/4 | 12519 | 93645 | 2229.6 | 50074 | 1053641 | 138 1/4 | 15011 | 112293 | 2673.6 | 60045 | 1383547 |
| 126 1/2 | 12568 | 94016 | 2238.5 | 50273 | 1059913 | 138 1/2 | 15066 | 112699 | 2683.3 | 60263 | 1391067 |
| 126 3/4 | 12618 | 94388 | 2247.3 | 50471 | 1066209 | 138 3/4 | 15120 | 113107 | 2693.0 | 60481 | 1398613 |
| 127 | 12668 | 94761 | 2256.2 | 50671 | 1072531 | 139 | 15175 | 113514 | 2702.7 | 60699 | 1406187 |
| 127 1/4 | 12718 | 95134 | 2265.1 | 50870 | 1078877 | 139 1/4 | 15229 | 113923 | 2712.5 | 60917 | 1413788 |
| 127 1/2 | 12768 | 95508 | 2274.0 | 51071 | 1085248 | 139 1/2 | 15284 | 114333 | 2722.2 | 61136 | 1421416 |
| 127 3/4 | 12818 | 95883 | 2282.9 | 51271 | 1091645 | 139 3/4 | 15339 | 114743 | 2732.0 | 61356 | 1429072 |
| 128 | 12868 | 96259 | 2291.9 | 51472 | 1098066 | 140 | 15394 | 115154 | 2741.8 | 61575 | 1436755 |
| 128 1/4 | 12918 | 96635 | 2300.8 | 51673 | 1104513 | 140 1/4 | 15449 | 115565 | 2751.6 | 61795 | 1444466 |
| 128 1/2 | 12969 | 97013 | 2309.8 | 51875 | 1110985 | 140 1/2 | 15504 | 115978 | 2761.4 | 62016 | 1452204 |
| 128 3/4 | 13019 | 97390 | 2318.8 | 52077 | 1117481 | 140 3/4 | 15559 | 116391 | 2771.2 | 62237 | 1459970 |
| 129 | 13070 | 97769 | 2327.8 | 52279 | 1124004 | 141 | 15615 | 116805 | 2781.1 | 62458 | 1467763 |
| 129 1/4 | 13121 | 98148 | 2336.9 | 52482 | 1130551 | 141 1/4 | 15670 | 117219 | 2790.9 | 62680 | 1475584 |
| 129 1/2 | 13171 | 98528 | 2345.9 | 52685 | 1137124 | 141 1/2 | 15725 | 117634 | 2800.8 | 62902 | 1483433 |
| 129 3/4 | 13222 | 98909 | 2355.0 | 52889 | 1143723 | 141 3/4 | 15781 | 118050 | 2810.7 | 63124 | 1491310 |
| 130 | 13273 | 99291 | 2364.1 | 53093 | 1150347 | 142 | 15837 | 118467 | 2820.6 | 63347 | 1499214 |
| 130 1/4 | 13324 | 99673 | 2373.2 | 53297 | 1156996 | 142 1/4 | 15893 | 118885 | 2830.6 | 63570 | 1507146 |
| 130 1/2 | 13376 | 100056 | 2382.3 | 53502 | 1163671 | 142 1/2 | 15948 | 119303 | 2840.5 | 63794 | 1515107 |
| 130 3/4 | 13427 | 100440 | 2391.4 | 53707 | 1170371 | 142 3/4 | 16005 | 119722 | 2850.5 | 64018 | 1523095 |
| 131 | 13478 | 100824 | 2400.6 | 53913 | 1177098 | 143 | 16061 | 120142 | 2860.5 | 64242 | 1531111 |
| 131 1/4 | 13530 | 101209 | 2409.7 | 54119 | 1183850 | 143 1/4 | 16117 | 120562 | 2870.5 | 64467 | 1539156 |
| 131 1/2 | 13581 | 101595 | 2418.9 | 54325 | 1190627 | 143 1/2 | 16173 | 120983 | 2880.6 | 64692 | 1547228 |
| 131 3/4 | 13633 | 101982 | 2428.1 | 54532 | 1197431 | 143 3/4 | 16230 | 121405 | 2890.6 | 64918 | 1555329 |
| 132 | 13685 | 102369 | 2437.4 | 54739 | 1204260 | 144 | 16286 | 121828 | 2900.7 | 65144 | 1563458 |
| 132 1/4 | 13737 | 102757 | 2446.6 | 54947 | 1211116 | 144 1/4 | 16343 | 122251 | 2910.7 | 65370 | 1571615 |
| 132 1/2 | 13789 | 103146 | 2455.9 | 55155 | 1217997 | 144 1/2 | 16399 | 122675 | 2920.8 | 65597 | 1579800 |
| 132 3/4 | 13841 | 103536 | 2465.1 | 55363 | 1224904 | 144 3/4 | 16456 | 123100 | 2931.0 | 65824 | 1588014 |
| 133 | 13893 | 103926 | 2474.4 | 55572 | 1231838 | 145 | 16513 | 123526 | 2941.1 | 66052 | 1596256 |
| 133 1/4 | 13945 | 104317 | 2483.7 | 55781 | 1238797 | 145 1/4 | 16570 | 123952 | 2951.2 | 66280 | 1604527 |
| 133 1/2 | 13998 | 104709 | 2493.1 | 55990 | 1245783 | 145 1/2 | 16627 | 124379 | 2961.4 | 66508 | 1612826 |
| 133 3/4 | 14050 | 105102 | 2502.4 | 56200 | 1252795 | 145 3/4 | 16684 | 124807 | 2971.6 | 66737 | 1621154 |
| 134 | 14103 | 105495 | 2511.8 | 56410 | 1259833 | 146 | 16742 | 125235 | 2981.8 | 66966 | 1629511 |
| 134 1/4 | 14155 | 105889 | 2521.2 | 56621 | 1266898 | 146 1/4 | 16799 | 125665 | 2992.0 | 67196 | 1637896 |
| 134 1/2 | 14208 | 106284 | 2530.6 | 56832 | 1273988 | 146 1/2 | 16856 | 126095 | 3002.3 | 67426 | 1646310 |
| 134 3/4 | 14261 | 106679 | 2540.0 | 57044 | 1281106 | 146 3/4 | 16914 | 126525 | 3012.5 | 67656 | 1654752 |
| 135 | 14314 | 107075 | 2549.4 | 57256 | 1288249 | 147 | 16972 | 126957 | 3022.8 | 67887 | 1663224 |
| 135 1/4 | 14367 | 107472 | 2558.9 | 57468 | 1295420 | 147 1/4 | 17029 | 127389 | 3033.1 | 68118 | 1671724 |
| 135 1/2 | 14420 | 107870 | 2568.3 | 57680 | 1302616 | 147 1/2 | 17087 | 127822 | 3043.4 | 68349 | 1680253 |
| 135 3/4 | 14473 | 108268 | 2577.8 | 57893 | 1309840 | 147 3/4 | 17145 | 128256 | 3053.7 | 68581 | 1688811 |
| 136 | 14527 | 108667 | 2587.3 | 58107 | 1317090 | 148 | 17203 | 128690 | 3064.0 | 68813 | 1697398 |
| 136 1/4 | 14580 | 109067 | 2596.8 | 58321 | 1324366 | 148 1/4 | 17262 | 129125 | 3074.4 | 69046 | 1706015 |
| 136 1/2 | 14634 | 109468 | 2606.4 | 58535 | 1331670 | 148 1/2 | 17320 | 129561 | 3084.8 | 69279 | 1714660 |
| 136 3/4 | 14687 | 109869 | 2615.9 | 58750 | 1339000 | 148 3/4 | 17378 | 129998 | 3095.2 | 69513 | 1723334 |
| 137 | 14741 | 110271 | 2625.5 | 58965 | 1346357 | 149 | 17437 | 130435 | 3105.6 | 69746 | 1732038 |
| 137 1/4 | 14795 | 110674 | 2635.1 | 59180 | 1353741 | 149 1/4 | 17495 | 130873 | 3116.0 | 69981 | 1740771 |
| 137 1/2 | 14849 | 111078 | 2644.7 | 59396 | 1361152 | 149 1/2 | 17554 | 131312 | 3126.5 | 70215 | 1749533 |
| 137 3/4 | 14903 | 111482 | 2654.3 | 59612 | 1368590 | 149 3/4 | 17613 | 131751 | 3136.9 | 70450 | 1758325 |
| | | | | | | 150 | 17671 | 132192 | 3147.4 | 70686 | 1767146 |

D-20 Tank Capacities, Horizontal Cylindrical Contents of Tanks with Flat Ends When Filled to Various Depths

| Diameter of tank inches | Full tank | Depth of liquid, in inches = h | | | | | | | | | | | | | | | | | | | |
|-------------------------|-----------|----------------------------------|-------|-------|-------|-------|-------|-------|-------|-------|--------|--------|--------|--------|--------|--------|--------|--------|--------|--------|--------|
| | | 3" | 6" | 9" | 12" | 15" | 18" | 21" | 24" | 27" | 30" | 33" | 36" | 39" | 42" | 45" | 48" | 51" | 54" | 57" | 60" |
| 12" | 5.88 | 1.15 | 2.94 | | | | | | | | | | | | | | | | | | |
| 18" | 13.22 | 1.45 | 3.86 | 6.61 | | | | | | | | | | | | | | | | | |
| 24" | 23.50 | 1.70 | 4.60 | 8.05 | 11.75 | | | | | | | | | | | | | | | | |
| 30" | 36.72 | 1.91 | 5.23 | 9.27 | 13.72 | 18.36 | | | | | | | | | | | | | | | |
| 36" | 52.88 | 2.12 | 5.79 | 10.34 | 15.43 | 20.85 | 26.44 | | | | | | | | | | | | | | |
| 42" | 71.97 | 2.28 | 6.31 | 11.31 | 16.97 | 23.07 | 29.47 | 35.99 | | | | | | | | | | | | | |
| 48" | 94.01 | 2.45 | 6.78 | 12.20 | 18.38 | 25.10 | 32.20 | 39.54 | 47.00 | | | | | | | | | | | | |
| 54" | 118.98 | 2.60 | 7.22 | 13.04 | 19.68 | 26.97 | 34.72 | 42.80 | 51.08 | 59.49 | | | | | | | | | | | |
| 60" | 146.89 | 2.75 | 7.64 | 13.82 | 20.91 | 28.72 | 37.06 | 45.82 | 54.87 | 64.11 | 73.44 | | | | | | | | | | |
| 66" | 177.73 | 2.89 | 8.04 | 14.56 | 22.07 | 30.37 | 39.28 | 48.65 | 58.39 | 68.41 | 78.59 | 88.86 | | | | | | | | | |
| 72" | 211.52 | 3.02 | 8.42 | 15.26 | 23.17 | 31.92 | 41.36 | 51.32 | 61.71 | 72.45 | 83.41 | 94.54 | 105.76 | | | | | | | | |
| 78" | 248.24 | 3.15 | 8.78 | 15.94 | 24.21 | 33.41 | 43.34 | 53.86 | 64.87 | 76.27 | 87.97 | 99.90 | 111.97 | 124.13 | | | | | | | |
| 84" | 287.90 | 3.26 | 9.12 | 16.57 | 25.24 | 34.85 | 45.24 | 56.29 | 67.87 | 79.91 | 92.30 | 104.98 | 117.85 | 130.87 | 143.95 | | | | | | |
| 90" | 330.49 | 3.43 | 9.46 | 17.20 | 26.20 | 36.21 | 47.05 | 58.61 | 70.75 | 83.39 | 96.43 | 109.81 | 123.45 | 137.28 | 151.23 | 165.25 | | | | | |
| 96" | 376.62 | 3.50 | 9.79 | 17.80 | 27.13 | 37.52 | 48.81 | 60.84 | 73.52 | 86.73 | 100.39 | 114.44 | 128.79 | 143.40 | 158.17 | 173.06 | 188.01 | | | | |
| 102" | 424.50 | 3.61 | 10.10 | 18.37 | 28.01 | 39.00 | 50.49 | 62.99 | 76.18 | 89.94 | 104.20 | 118.89 | 133.92 | 149.25 | 164.81 | 180.53 | 196.37 | 212.25 | | | |
| 108" | 476.10 | 3.71 | 10.39 | 18.94 | 28.90 | 40.03 | 52.14 | 65.09 | 78.74 | 93.04 | 107.87 | 123.17 | 138.87 | 154.89 | 171.19 | 187.71 | 204.37 | 221.14 | 238.05 | | |
| 114" | 530.25 | 3.78 | 10.74 | 19.49 | 29.75 | 41.22 | 53.73 | 67.10 | 81.24 | 96.05 | 111.43 | 127.31 | 143.63 | 160.33 | 177.33 | 194.60 | 212.05 | 229.65 | 247.37 | 265.13 | |
| 120" | 587.54 | 3.94 | 10.98 | 20.02 | 30.57 | 42.39 | 55.26 | 69.06 | 83.65 | 98.95 | 114.87 | 131.32 | 148.25 | 165.58 | 183.27 | 201.24 | 219.46 | 237.87 | 256.43 | 275.08 | 293.77 |

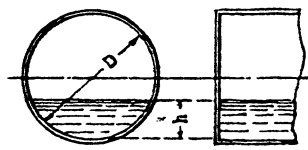

To ascertain the contents of a tank over one-half full: Let h = depth of unfilled portion. Find from the table the quantity corresponding to a depth h . Subtract this quantity from the contents of a full tank.

Contents in U.S. gallons per 1 foot of length.
By permission, The Permutit Co., Inc., Data Book, 1953.

D-21 Tank Capacities, Horizontal Cylindrical Contents of Standards Dished Heads When Filled to Various Depths

| Diameter of head inches | Full head | Depth of liquid, in inches = h | | | | | | | | | | | | | | | | | | | |
|-------------------------|-----------|----------------------------------|------|-------|-------|-------|-------|-------|-------|-------|-------|-------|-------|-------|--------|--------|--------|--------|--------|--------|--------|
| | | 3" | 6" | 9" | 12" | 15" | 18" | 21" | 24" | 27" | 30" | 33" | 36" | 39" | 42" | 45" | 48" | 51" | 54" | 57" | 60" |
| 12" | 0.40 | 0.05 | 0.20 | | | | | | | | | | | | | | | | | | |
| 18" | 1.36 | 0.07 | 0.32 | 0.68 | | | | | | | | | | | | | | | | | |
| 24" | 3.22 | 0.08 | 0.41 | 0.95 | 1.61 | | | | | | | | | | | | | | | | |
| 30" | 6.30 | 0.10 | 0.49 | 1.18 | 2.10 | 3.15 | | | | | | | | | | | | | | | |
| 36" | 10.88 | 0.11 | 0.56 | 1.39 | 2.54 | 3.92 | 5.44 | | | | | | | | | | | | | | |
| 42" | 17.28 | 0.12 | 0.63 | 1.59 | 2.94 | 4.64 | 6.57 | 8.64 | | | | | | | | | | | | | |
| 48" | 25.79 | 0.13 | 0.68 | 1.75 | 3.31 | 5.29 | 7.62 | 10.19 | 12.89 | | | | | | | | | | | | |
| 54" | 36.72 | 0.14 | 0.74 | 1.90 | 3.64 | 5.91 | 8.60 | 11.65 | 14.95 | 18.36 | | | | | | | | | | | |
| 60" | 50.37 | 0.14 | 0.82 | 2.07 | 3.98 | 6.49 | 9.54 | 13.03 | 16.87 | 20.96 | 25.18 | | | | | | | | | | |
| 66" | 67.04 | 0.15 | 0.83 | 2.19 | 4.25 | 6.98 | 10.35 | 14.30 | 18.68 | 23.43 | 28.42 | 33.52 | | | | | | | | | |
| 72" | 87.04 | 0.16 | 0.88 | 2.32 | 4.52 | 7.47 | 11.15 | 15.48 | 20.38 | 25.74 | 31.46 | 37.43 | 43.52 | | | | | | | | |
| 78" | 110.66 | 0.17 | 0.93 | 2.44 | 4.79 | 7.97 | 11.94 | 16.65 | 22.02 | 27.97 | 34.39 | 41.16 | 48.20 | 55.33 | | | | | | | |
| 84" | 138.22 | 0.18 | 0.98 | 2.59 | 5.07 | 8.44 | 12.69 | 17.78 | 23.60 | 30.11 | 37.19 | 44.75 | 52.67 | 60.83 | 69.11 | | | | | | |
| 90" | 170.01 | 0.18 | 1.00 | 2.68 | 5.33 | 8.91 | 13.44 | 18.96 | 25.12 | 32.18 | 39.90 | 48.22 | 56.99 | 66.14 | 75.52 | 85.00 | | | | | |
| 96" | 206.32 | 0.20 | 1.07 | 2.83 | 5.59 | 9.36 | 14.14 | 19.90 | 26.60 | 34.17 | 42.52 | 51.53 | 61.13 | 71.22 | 81.66 | 92.34 | 103.16 | | | | |
| 102" | 247.48 | 0.22 | 1.14 | 3.01 | 5.89 | 9.87 | 14.92 | 21.01 | 28.11 | 36.18 | 45.19 | 54.91 | 65.31 | 76.29 | 87.73 | 99.56 | 111.59 | 123.74 | | | |
| 108" | 293.77 | 0.20 | 1.13 | 3.03 | 6.04 | 10.21 | 15.50 | 21.93 | 29.47 | 38.03 | 47.56 | 57.97 | 69.14 | 81.05 | 93.53 | 106.47 | 119.76 | 133.26 | 146.88 | | |
| 114" | 345.51 | 0.21 | 1.16 | 3.12 | 6.25 | 10.55 | 16.06 | 22.80 | 30.70 | 39.73 | 49.81 | 60.88 | 72.85 | 85.61 | 99.05 | 113.07 | 127.56 | 142.41 | 157.51 | 172.75 | |
| 120" | 402.27 | 0.21 | 1.19 | 3.23 | 6.47 | 10.93 | 16.68 | 23.70 | 31.96 | 41.43 | 52.04 | 63.73 | 76.40 | 89.95 | 104.32 | 119.39 | 135.04 | 151.15 | 167.62 | 184.32 | 201.13 |

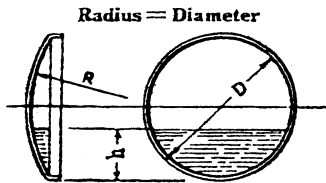

To ascertain the contents of a head over one-half full: Let h = depth of unfilled portion. Find from the table the quantity corresponding to a depth h . Subtract this quantity from the contents of a full head.

Contents in U.S. gallons for one head only. This table is only approximate, but close enough for practical use.
By permission, The Permutit Co., Inc., Data Book, 1953.

D-22

Miscellaneous Formulas

(Courtesy of Chicago Bridge and Iron Co.)

1. Area of Roofs.

Umbrella Roofs:

D = diameter of tank in feet.

Surface area in square feet $\left\{ \begin{array}{l} = 0.842 D^2 \text{ (when radius = diameter)} \\ = 0.882 D^2 \text{ (when radius = 0.8 diameter)} \end{array} \right.$

Conical Roofs:

Surface area in square feet $\left\{ \begin{array}{l} = 0.787 D^2 \text{ (when pitch is } \frac{3}{4} \text{ in 12)} \\ = 0.792 D^2 \text{ (when pitch is } 1\frac{1}{2} \text{ in 12)} \end{array} \right.$

2. Average weights.

Steel —490 pounds per cubic foot—specific gravity 7.85

Wrought iron —485 pounds per cubic foot—specific gravity 7.77

Cast iron —450 pounds per cubic foot—specific gravity 7.21

1 cubic foot air or gas at 32° F., 760 m.m. barometer = molecular weight x 0.0027855 pounds.

3. Expansion in steel pipe = 0.78 inch per 100 lineal feet per 100 degrees Fahr. change in temperature = 0.412 inch per mile per degree Fahr. temperature change.

4. Linear coefficients of expansion per degree increase in temperature:

| | Per Degree Fahrenheit | Per Degree Centigrade |
|--------------------------|-----------------------|-----------------------|
| STRUCTURAL STEEL—A-7 | | |
| 70° to 200° F..... | 0.0000067 | — |
| 21.1° to 93° C..... | — | 0.0000121 |
| STAINLESS STEEL—TYPE 304 | | |
| 32° to 932° F..... | 0.0000102 | — |
| 0° to 500° C..... | — | 0.0000184 |
| ALUMINUM | | |
| -76° to 68° F..... | 0.0000120 | — |
| -60° to 20° C..... | — | 0.0000216 |

5. To determine the net thickness of shells for horizontal cylindrical pressure tanks:

$$T = \frac{6PD}{S}$$

P = working pressure in pounds per square inch

D = diameter of cylinder in feet

S = allowable unit working stress in pounds per square inch

T = Net thickness in inches

Resulting net thickness must be corrected to gross or actual thickness by dividing by joint efficiency.

6. To determine the net thickness of heads for cylindrical pressure tanks:

(6a) Ellipsoidal or Bumped Heads:

$$T = \frac{6PD}{S}$$

T, P and D as in formula 5

(6b) Dished or Basket Heads:

$$T = \frac{10.6P(MR)}{S}$$

T, S and P as in formula 5

MR = principal radius of head in feet

Resulting net thickness of heads is both net and gross thickness if one piece seamless heads are used, otherwise net thickness must be corrected to gross thickness as above.

Formulas 5 and 6 must often be modified to comply with various engineering codes, and state and municipal regulations. Calculated gross plate thicknesses are sometimes arbitrarily increased to provide an additional allowance for corrosion.

7. Heads for Horizontal Cylindrical Tanks:

Hemi-ellipsoidal Heads have an ellipsoidal cross section, usually with minor axis equal to one half the major axis—that is, depth = $\frac{1}{4} D$, or more.

Dished or Basket Heads consist of a spherical segment normally dished to a radius equal to the inside diameter of the tank cylinder (or within a range of 6 inches plus or minus) and connected to the straight cylindrical flange by a "knuckle" whose inside radius is usually not less than 6 per cent of the inside diameter of the cylinder nor less than 3 times the thickness of the head plate. Basket heads closely approximate hemi-ellipsoidal heads.

Bumped Heads consist of a spherical segment joining the tank cylinder directly without the transition "knuckle." The radius = D, or less. This type of head is used only for pressures of 10 pounds per square inch or less, excepting where a compression ring is placed at the junction of head and shell.

Surface Area of Heads:

(7a) Hemi-ellipsoidal Heads:

$$S = \pi R^2 [1 + K^2(2-K)]$$

S = surface area in square feet

R = radius of cylinder in feet

K = ratio of the depth of the head (not including the straight flange) to the radius of the cylinder

The above formula is not exact but is within limits of practical accuracy.

(7b) Dished or Basket Heads:

Formula (7a) gives surface area within practical limits.

(7c) Bumped Heads:

$$S = \pi R^2 (1 + K^2)$$

S, R, and K as in formula (7a)

Volume of Heads:

(7d) Hemi-ellipsoidal Heads:

$$V = \frac{2}{3} \pi K R^3$$

R = radius of cylinder in feet

K = ratio of the depth of the head (not including the straight flange) to the radius of the cylinder

(7e) Dished or Basket Heads:

Formula (7d) gives volume within practical limits.

(7f) Bumped Heads:

$$V = \frac{1}{2} \pi K R^3 (1 + \frac{1}{3} K^2)$$

V, K and R as in formula (7d)

Note: K in above formulas may be determined as follows:

Hemi-ellipsoidal heads—K is known

$$\text{Dished Heads—} K = M - \sqrt{(M-1)(M+1-2m)}$$

$$\text{Bumped Heads—} K = [M - \sqrt{M^2 - 1}]$$

MR = principal radius of head in feet

mR = radius of knuckle in feet

R = radius of cylinder in feet

$$M = \frac{MR}{R} \quad m = \frac{mR}{R}$$

For bumped heads m = 0

8. Total volume or length of shell in cylindrical tank with ellipsoidal or hemispherical heads:

V = Total volume

L = Length of cylindrical shell

KD = Depth of head

$$V = \frac{\pi D^2}{4} (L + 1\frac{1}{2} KD)$$

$$L = (V \div \frac{\pi D^2}{4}) - 1\frac{1}{2} KD$$

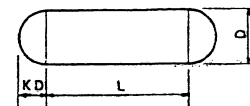

D-22
(Continued). Miscellaneous Formulas

9. Volume or contents of partially filled horizontal cylindrical tanks:

(9a) Tank cylinder or shell (straight portion only)

$$Q = RL \left[\left(\frac{\pi \Theta^3}{180} \right) - \sin \Theta \cos \Theta \right]$$

Q = partially filled volume or contents in cubic feet

R = radius of cylinder in feet

L = length of straight portion of cylinder in feet

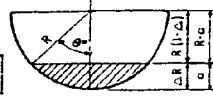

The straight portion or flange of the heads must be considered a part of the cylinder. The length of flange depends upon the diameter of tank and thickness of head but ranges usually between 2 and 4 inches.

a = Δ R = depth of liquid in feet

$$\Delta = \frac{a}{R} = \text{a ratio}$$

$$\cos \Theta = 1 - \Delta, \text{ or } \frac{R-a}{R}$$

Θ = degrees

(9b) Hemi-ellipsoidal Heads:

$$Q = \frac{3}{4} V \Delta^2 (1 - \frac{1}{4} \Delta)$$

Q = partially filled volume or contents in cubic feet

V = total volume of one head per formula (7d)

$$\Delta = \frac{a}{R} = \text{a ratio}$$

a = Δ R = depth of liquid in feet

R = radius of cylinder in feet

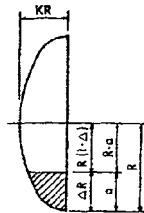

(9c) Dished or Basket Heads:

Formula (9b) gives partially filled volume within practical limits, and formula (7d) gives V within practical limits.

(9d) Bumped Heads:

Formula (9b) gives partially filled volume within practical limits, and formula (7f) gives V.

Note: To obtain the volume or quantity of liquid in partially filled tanks, add the volume per formula (9a) for the cylinder or straight portion to twice (for 2 heads) the volume per formula (9b), (9c) or (9d) for the type of head concerned.

10. Volume or contents of partially filled hemi-ellipsoidal heads with major axis vertical:

Q = Partially filled volume or contents in cubic feet

V = Total volume of one head per formula (7d)

R = Radius of cylinder in feet

(10a) Upper Head:

$$Q = 1\frac{1}{2} V \Delta (1 - \frac{1}{2} \Delta^2)$$

$$\Delta = \frac{a}{KR} = \text{a ratio}$$

a = Δ KR = depth of liquid in feet

(10b) Lower Head:

$$Q = 1\frac{1}{2} V \Delta^2 (1 - \frac{1}{2} \Delta)$$

$$\Delta = \frac{a}{KR} = \text{a ratio}$$

a = Δ KR = depth of liquid in feet

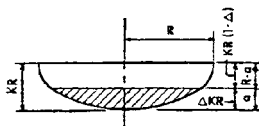
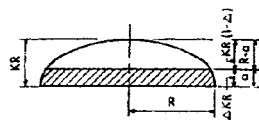

D-23
Decimal Equivalent in Inches, Feet and Millimeters

| In. Equiv. for Decimal of In. | Decimals | Millimeter Equiv. for Decimal of In. | In. Equiv. for Decimal of Ft. |
|-------------------------------|----------|--------------------------------------|-------------------------------|
| 1/64 | .0156 | 0.397 | 3/16 |
| 1/32 | .0313 | 0.794 | 3/8 |
| 3/64 | .0469 | 1.191 | 9/16 |
| 1/8 | .0625 | 1.588 | 3/4 |
| 5/64 | .0781 | 1.984 | 17/16 |
| 3/32 | .0938 | 2.381 | 1 1/8 |
| 7/64 | .1094 | 2.778 | 1 5/16 |
| 1/4 | .1250 | 3.175 | 1 1/2 |
| 9/64 | .1406 | 3.572 | 1 11/16 |
| 5/32 | .1563 | 3.969 | 1 7/8 |
| 11/64 | .1719 | 4.366 | 2 1/16 |
| 3/16 | .1875 | 4.763 | 2 1/4 |
| 13/64 | .2031 | 5.159 | 2 3/8 |
| 7/32 | .2188 | 5.556 | 2 5/8 |
| 15/64 | .2344 | 5.953 | 2 11/16 |
| 1/4 | .2500 | 6.350 | 3 |
| 17/64 | .2656 | 6.747 | 3 1/16 |
| 9/32 | .2813 | 7.144 | 3 3/8 |
| 19/64 | .2969 | 7.541 | 3 7/16 |
| 5/16 | .3125 | 7.938 | 3 1/2 |
| 21/64 | .3281 | 8.334 | 3 5/16 |
| 11/32 | .3438 | 8.731 | 4 1/8 |
| 23/64 | .3594 | 9.128 | 4 3/16 |
| 3/8 | .3750 | 9.525 | 4 1/2 |
| 25/64 | .3906 | 9.922 | 4 7/16 |
| 13/32 | .4063 | 10.319 | 4 7/8 |
| 27/64 | .4219 | 10.716 | 5 1/16 |
| 7/16 | .4375 | 11.113 | 5 1/4 |
| 29/64 | .4531 | 11.509 | 5 5/16 |
| 15/32 | .4688 | 11.906 | 5 7/8 |
| 31/64 | .4844 | 12.303 | 5 13/16 |
| 1/2 | .5000 | 12.700 | 6 |
| 33/64 | .5156 | 13.097 | 6 1/16 |
| 17/32 | .5313 | 13.494 | 6 3/8 |
| 35/64 | .5469 | 13.891 | 6 5/16 |
| 9/16 | .5625 | 14.288 | 6 3/4 |
| 37/64 | .5781 | 14.684 | 6 15/16 |
| 19/32 | .5938 | 15.081 | 7 1/8 |
| 39/64 | .6094 | 15.478 | 7 5/16 |
| 5/8 | .6250 | 15.875 | 7 1/2 |
| 41/64 | .6406 | 16.272 | 7 11/16 |
| 21/32 | .6563 | 16.669 | 7 7/8 |
| 43/64 | .6719 | 17.066 | 8 1/16 |
| 11/16 | .6875 | 17.463 | 8 1/4 |
| 45/64 | .7031 | 17.859 | 8 3/16 |
| 23/32 | .7188 | 18.256 | 8 5/8 |
| 47/64 | .7344 | 18.653 | 8 13/16 |
| 3/4 | .7500 | 19.050 | 9 |
| 49/64 | .7656 | 19.447 | 9 1/16 |
| 25/32 | .7813 | 19.844 | 9 3/8 |
| 51/64 | .7969 | 20.241 | 9 7/16 |
| 13/16 | .8125 | 20.638 | 9 1/2 |
| 53/64 | .8281 | 21.034 | 9 5/16 |
| 27/32 | .8438 | 21.431 | 10 1/8 |
| 55/64 | .8594 | 21.828 | 10 3/16 |
| 7/8 | .8750 | 22.225 | 10 1/2 |
| 57/64 | .8906 | 22.622 | 10 11/16 |
| 29/32 | .9063 | 23.019 | 10 7/8 |
| 39/64 | .9219 | 23.416 | 11 1/16 |
| 15/16 | .9375 | 23.813 | 11 1/4 |
| 61/64 | .9531 | 24.209 | 11 7/16 |
| 31/32 | .9688 | 24.606 | 11 5/8 |
| 63/64 | .9844 | 25.003 | 11 13/16 |
| 1 | 1.0000 | 25.400 | 12 |

D-24
(Continued).

D-24
(by permission of Buffalo Tank Div., Bethlehem Steel Corp.)

PROPERTIES OF THE CIRCLE

- Circumference = $0.28318 r = 3.14159 d$
- Diameter = 0.31831 circumference
- Area = $3.14159 r^2$
- Arc $a = \frac{\pi r A^\circ}{180^\circ} = 0.017453 r A^\circ$
- Angle $A^\circ = \frac{180^\circ a}{\pi r} = 87.29578 \frac{a}{r}$
- Radius $r = \frac{4 b^2 + c^2}{8 b}$
- Chord $c = 2 \sqrt{2 br - b^2} = 2 r \sin \frac{A}{2}$
- Rise $b = r - \frac{1}{2} \sqrt{4 r^2 - c^2} = \frac{c}{2} \tan \frac{A}{4}$
- $y = b - r + \sqrt{r^2 - x^2}$
- $x = \sqrt{r^2 - (r + y - b)^2}$

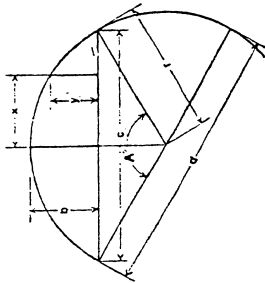

Diameter of circle of equal periphery as square = 1.27324 side of square
 Diameter of circle circumscribed about square = 1.41421 side of square
 Side of square inscribed in circle = 0.70711 diameter of circle

CIRCULAR SECTOR

- r = radius of circle
- y = angle ncp in degrees
- Area of Sector ncpo = $\frac{1}{2}$ (length of arc ncp X r)
- = Area of Circle X $\frac{y}{360}$
- = $0.0087266 X r^2 X y$

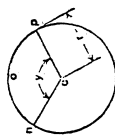

CIRCULAR SEGMENT

- r = radius of circle
- x = chord
- b = rise
- Area of Segment ncp = Area of Sector ncpo - Area of triangle ncp
- = $\frac{1}{2}$ (Length of arc ncp X r) - $x(r - b)$
- Area of Segment nsp = Area of Circle - Area of Segment ncp

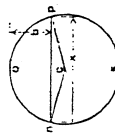

VALUES FOR FUNCTIONS OF π

- $\pi = 3.14159265359$, $\log = 0.4971499$
- $\frac{1}{\pi} = 0.3183099$, $\log = \bar{1}.5028501$
- $\frac{1}{\pi^2} = 0.1013212$, $\log = \bar{1}.0057002$
- $\frac{1}{\pi^3} = 0.0322515$, $\log = \bar{2}.5085503$
- $\frac{1}{\pi^4} = 0.0097266$, $\log = \bar{3}.2657796$
- $\frac{1}{\pi^5} = 0.0030932$, $\log = \bar{4}.5011914$
- $\frac{1}{\pi^6} = 0.00097266$, $\log = \bar{5}.2657796$
- $\frac{1}{\pi^7} = 0.00030932$, $\log = \bar{6}.5011914$
- $\frac{1}{\pi^8} = 0.000097266$, $\log = \bar{7}.2657796$
- $\frac{1}{\pi^9} = 0.000030932$, $\log = \bar{8}.5011914$
- $\frac{1}{\pi^{10}} = 0.0000097266$, $\log = \bar{9}.2657796$

AREA OF PLANE FIGURES

- Triangle:** Base x $\frac{1}{2}$ perpendicular height.
- $\sqrt{s(s-a)(s-b)(s-c)}$
- $s = \frac{1}{2}$ sum of the three sides a, b and c .
- Trapezium:** Sum of area of the two triangles.
- Trapezoid:** $\frac{1}{2}$ sum of parallel sides x perpendicular height.
- Parallelogram:** Base x perpendicular height.
- Regular Polygon:** $\frac{1}{2}$ sum of sides x inside radius.
- $\pi r^2 = 0.78540 \times \text{dia.}^2 = 0.07958 \times \text{circumference}^2$
- Circle:** $\pi r^2 = 0.0087266 r^2 A^\circ = \text{arc} \times \frac{1}{2}$ radius.
- $\frac{\pi r^2 A^\circ}{360}$
- Sector of Circle:** $\frac{r^2}{2} (\frac{\pi A^\circ}{180} - \sin A^\circ)$
- Segment of Circle:** $\frac{r^2}{2} (\frac{\pi A^\circ}{180} - \sin A^\circ)$
- Circle of same area as square:** diameter = side x 1.12838
- Square of same area as circle:** side = diameter x 0.88623
- Ellipse:** Long diameter x short diameter x 0.78540
- Parabola:** Base x $\frac{2}{3}$ perpendicular height.

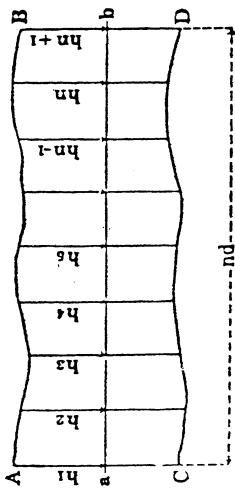

Divide any plane surface A, B, C, D, along a line $n-b$ into an even number, n , of parallel and sufficiently small strips, d , whose ordinates are $h_1, h_2, h_3, h_4, h_5, \dots, h_{n-1}, h_n$, and considering contours between three ordinates as parabolic curves, then for section ABCD,

$$\text{Area} = \frac{d}{3} [h_1 + h_n + 4(h_2 + h_4 + \dots + h_{n-2}) + 2(h_3 + h_5 + \dots + h_{n-1})]$$

or, approximately, Area = Sum of ordinates x width, d .

VOLUME OF A WEDGE

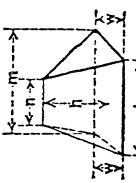

This formula is useful in obtaining the contents of special, wedge-shaped, tank bottoms.

$$\text{Volume} = \frac{wh}{6} (1 + m + n)$$

D-24
(Continued).

PROPERTIES OF SECTIONS

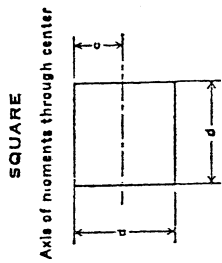

SQUARE
Axis of moments through center

$$A = d^2$$

$$c = \frac{d}{2}$$

$$I = \frac{d^4}{12}$$

$$S = \frac{d^3}{6}$$

$$r = \frac{d}{\sqrt{12}} = .288675 d$$

SQUARE

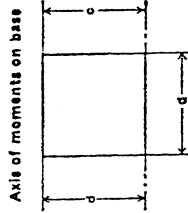

SQUARE
Axis of moments on base

$$A = d^2$$

$$c = d$$

$$I = \frac{d^4}{3}$$

$$S = \frac{d^3}{3}$$

$$r = \frac{d}{\sqrt{3}} = .577350 d$$

SQUARE

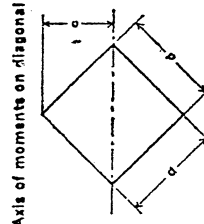

SQUARE
Axis of moments on diagonal

$$A = d^2$$

$$c = \frac{d}{\sqrt{2}} = .707107 d$$

$$I = \frac{d^4}{12}$$

$$S = \frac{d^3}{6\sqrt{2}} = .117851 d^3$$

$$r = \frac{d}{\sqrt{12}} = .288675 d$$

RECTANGLE

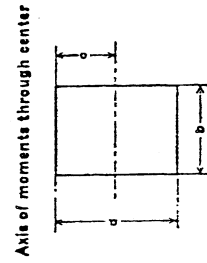

RECTANGLE
Axis of moments through center

$$A = bd$$

$$c = \frac{d}{2}$$

$$I = \frac{bd^3}{12}$$

$$S = \frac{bd^2}{6}$$

$$r = \frac{d}{\sqrt{12}} = .288675 d$$

D-24
(Continued).

TRIGONOMETRIC FORMULAS

Radius AF = 1

$$\sin A = \frac{a}{c}$$

$$\cos A = \frac{b}{c}$$

$$\tan A = \frac{a}{b}$$

$$\cot A = \frac{b}{a}$$

$$\sec A = \frac{c}{a}$$

$$\csc A = \frac{c}{b}$$

$$\sin^2 A + \cos^2 A = 1$$

$$\sec^2 A = 1 + \tan^2 A$$

$$\csc^2 A = 1 + \cot^2 A$$

$$\sin A \cos A = \frac{1}{2} \sin 2A$$

$$\cos A \sin A = \frac{1}{2} \sin 2A$$

$$\tan A \cot A = 1$$

$$\sec A \csc A = \frac{1}{\sin A \cos A}$$

$$\sin A \tan A = \frac{a^2}{c^2} \sin A$$

$$\cos A \tan A = \frac{a}{c} \sin A$$

$$\sin A \cot A = \frac{b}{c} \sin A$$

$$\cos A \cot A = \frac{b}{c} \cos A$$

$$\sec A \tan A = \frac{c}{a} \sin A$$

$$\csc A \cot A = \frac{c}{b} \cos A$$

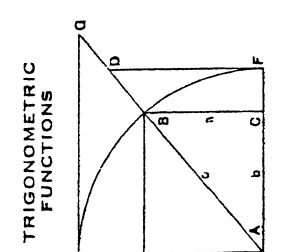

RIGHT ANGLED TRIANGLES

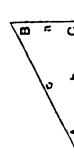

| Known | A | B | a | b | c | Area |
|-------|------------------------|------------------------|--------------------|---|---|-------------------------------|
| a, b | $\tan A = \frac{a}{b}$ | $\tan B = \frac{b}{a}$ | $\sqrt{a^2 + b^2}$ | | | $\frac{ab}{2}$ |
| a, c | $\sin A = \frac{a}{c}$ | $\cos B = \frac{a}{c}$ | $\sqrt{c^2 - a^2}$ | | | $\frac{a\sqrt{c^2 - a^2}}{2}$ |
| A, a | | $90^\circ - A$ | $a \cot A$ | | | $\frac{a^2 \cot A}{2}$ |
| A, b | | $90^\circ - A$ | $b \tan A$ | | | $\frac{b^2 \tan A}{2}$ |
| A, c | | $90^\circ - A$ | $c \sin A$ | | | $\frac{c^2 \sin^2 A}{4}$ |

OBlique angled triangles

| Known | A | B | C | a | b | c | Area |
|---------|---|---|---|---|---|---|-------------------------|
| a, b, c | $\cos \frac{1}{2} A = \sqrt{\frac{s(s-a)}{bc}}$ | $\cos \frac{1}{2} B = \sqrt{\frac{s(s-b)}{ac}}$ | $\cos \frac{1}{2} C = \sqrt{\frac{s(s-c)}{ab}}$ | | | | $\frac{1}{2} ab \sin C$ |
| a, A, B | | $\sin B = \frac{b \sin A}{a}$ | $180^\circ - (A+B)$ | | | | $\frac{1}{2} ab \sin C$ |
| a, b, A | | $\sin B = \frac{b \sin A}{a}$ | | | | | $\frac{1}{2} ab \sin C$ |
| a, b, C | $\tan A = \frac{a \sin C}{b - a \cos C}$ | | | | | | $\frac{1}{2} ab \sin C$ |

D-24
(Continued).

PROPERTIES OF SECTIONS

RECTANGLE

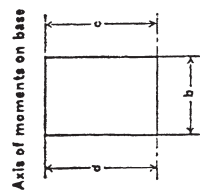

$$A = bd$$

$$c = \frac{d}{2}$$

$$I = \frac{bd^3}{3}$$

$$S = \frac{bd^2}{3}$$

$$r = \frac{d}{\sqrt{3}} = .577350 d$$

RECTANGLE

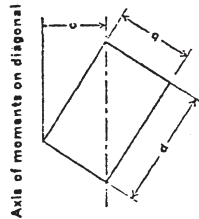

$$A = bd$$

$$c = \frac{bd}{\sqrt{b^2 + d^2}}$$

$$I = \frac{bd^3}{6(b^2 + d^2)}$$

$$S = \frac{bd^2}{6\sqrt{b^2 + d^2}}$$

$$r = \frac{bd}{\sqrt{6(b^2 + d^2)}}$$

RECTANGLE

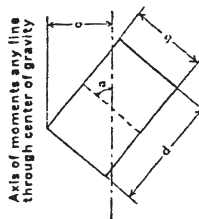

$$A = bd$$

$$c = \frac{b \sin \alpha + d \cos \alpha}{2}$$

$$I = \frac{bd(b^2 \sin^2 \alpha + d^2 \cos^2 \alpha)}{12}$$

$$S = \frac{bd(b^2 \sin \alpha + d^2 \cos \alpha)}{6(b \sin \alpha + d \cos \alpha)}$$

$$r = \sqrt{\frac{b^2 \sin^2 \alpha + d^2 \cos^2 \alpha}{12}}$$

HOLLOW RECTANGLE

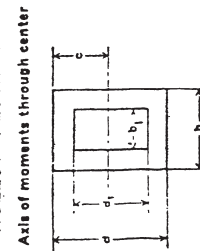

$$A = bd - b_1d_1$$

$$c = \frac{d}{2}$$

$$I = \frac{bd^3 - b_1d_1^3}{12}$$

$$S = \frac{bd^2 - b_1d_1^2}{6d}$$

$$r = \sqrt{\frac{bd^3 - b_1d_1^3}{12A}}$$

PROPERTIES OF SECTIONS

EQUAL RECTANGLES

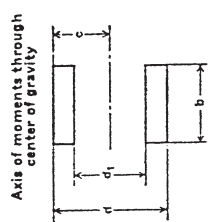

$$A = b(d - d_1)$$

$$c = \frac{d}{2}$$

$$I = \frac{b(d^3 - d_1^3)}{12}$$

$$S = \frac{b(d^2 - d_1^2)}{6d}$$

$$r = \sqrt{\frac{d^3 - d_1^3}{12(d - d_1)}}$$

UNEQUAL RECTANGLES

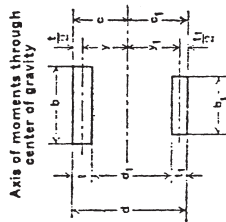

$$A = bt + b_1t_1$$

$$c = \frac{\frac{1}{2}bt^2 + b_1t_1(d - \frac{1}{2}t_1)}{A}$$

$$I = \frac{bt^3 + b_1t_1^3}{12} + \frac{bt_1t^2}{12} + \frac{b_1t_1^2t}{12}$$

$$S = \frac{I}{c}$$

$$r = \sqrt{\frac{I}{A}}$$

TRIANGLE

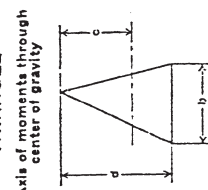

$$A = \frac{bd}{2}$$

$$c = \frac{2d}{3}$$

$$I = \frac{bd^3}{36}$$

$$S = \frac{bd^2}{24}$$

$$r = \frac{d}{\sqrt{18}} = .235702 d$$

TRIANGLE

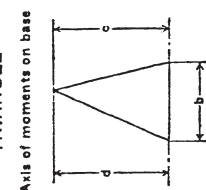

$$A = \frac{bd}{2}$$

$$c = d$$

$$I = \frac{bd^3}{12}$$

$$S = \frac{bd^2}{12}$$

$$r = \frac{d}{\sqrt{6}} = .408248 d$$

D-24
(Continued).

PROPERTIES OF SECTIONS

PARABOLA

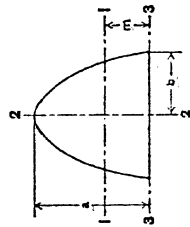

$$A = \frac{1}{3} ab$$

$$m = \frac{2}{5} a$$

$$l_1 = \frac{16}{175} a^2 b$$

$$l_2 = \frac{4}{15} ab^2$$

$$l_3 = \frac{32}{105} a^2 b$$

HALF PARABOLA

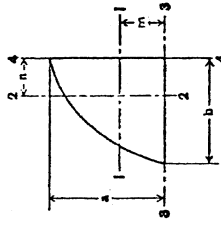

$$A = \frac{2}{3} ab$$

$$m = \frac{2}{5} a$$

$$n = \frac{3}{8} b$$

$$l_1 = \frac{8}{175} a^2 b$$

$$l_2 = \frac{19}{480} ab^2$$

$$l_3 = \frac{16}{105} a^2 b$$

$$l_4 = \frac{2}{15} ab^2$$

COMPLEMENT OF HALF PARABOLA

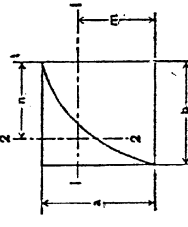

$$A = \frac{1}{3} ab$$

$$m = \frac{7}{10} a$$

$$n = \frac{3}{4} b$$

$$l_1 = \frac{37}{2100} a^2 b$$

$$l_2 = \frac{1}{80} ab^2$$

PARABOLIC FILLET IN RIGHT ANGLE

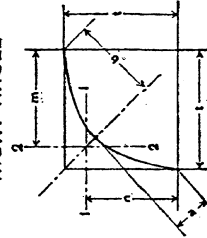

$$A = \frac{1}{2\sqrt{2}} ab$$

$$m = \frac{1}{\sqrt{2}} a$$

$$n = \frac{1}{6} b$$

$$l_1 = \frac{11}{875\sqrt{2}} ab^2$$

$$l_2 = \frac{1}{10} ab^2$$

D-24
(Continued).

PROPERTIES OF SECTIONS

TRAPEZOID

Axis of moments through center of gravity

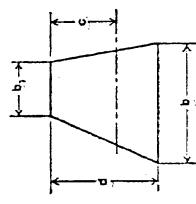

$$A = \frac{d(b_1 + b_2)}{2}$$

$$c = \frac{d(2b_1 + b_2)}{3(b_1 + b_2)}$$

$$l = \frac{d^2 (b_1^2 + 4b_1b_2 + b_2^2)}{36(b_1 + b_2)}$$

$$S = \frac{d^2 (b_1^2 + 4b_1b_2 + b_2^2)}{12(2b_1 + b_2)}$$

$$r = \frac{d}{6(b_1 + b_2)} \sqrt{2(b_1^2 + 4b_1b_2 + b_2^2)}$$

CIRCLE

Axis of moments through center

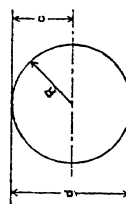

$$A = \frac{\pi d^2}{4} = \pi R^2 = .785398 d^2 = 3.141593 R^2$$

$$c = \frac{d}{2} = R$$

$$l = \frac{\pi d^4}{64} = \frac{\pi R^4}{4} = .049087 d^4 = .785398 R^4$$

$$S = \frac{\pi d^3}{32} = \frac{\pi R^3}{4} = .098175 d^3 = .785398 R^3$$

$$r = \frac{d}{4} = \frac{R}{2}$$

HOLLOW CIRCLE

Axis of moments through center

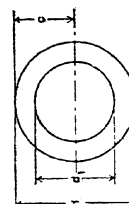

$$A = \frac{\pi(d^2 - d_1^2)}{4} = .785398 (d^2 - d_1^2)$$

$$c = \frac{d}{2}$$

$$l = \frac{\pi(d^4 - d_1^4)}{64} = .049087 (d^4 - d_1^4)$$

$$S = \frac{\pi(d^3 - d_1^3)}{32} = .098175 \frac{d^3 - d_1^3}{d}$$

$$r = \frac{\sqrt{d^2 + d_1^2}}{4}$$

HALF CIRCLE

Axis of moments through center of gravity

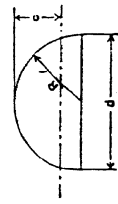

$$A = \frac{\pi R^2}{2} = 1.570796 R^2$$

$$c = R \left(1 - \frac{4}{3\pi}\right) = .575587 R$$

$$l = R^4 \left(\frac{\pi}{8} - \frac{8}{9\pi}\right) = .109737 R^4$$

$$S = \frac{R^3 (9\pi^2 - 64)}{24(3\pi - 4)} = .100687 R^3$$

$$r = R \frac{\sqrt{9\pi^2 - 64}}{6\pi} = .264336 R$$

D-24
(Continued).

PROPERTIES OF SECTIONS

• HALF ELLIPSE

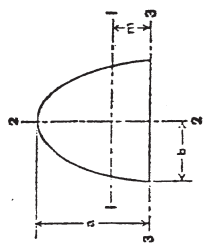

$$A = \frac{1}{2} \pi ab$$

$$m = \frac{4a}{3\pi}$$

$$I_1 = a^3 b \left(\frac{\pi}{8} - \frac{6}{9\pi} \right)$$

$$I_2 = \frac{1}{8} \pi ab^3$$

$$I_3 = \frac{1}{8} \pi ab^3$$

• QUARTER ELLIPSE

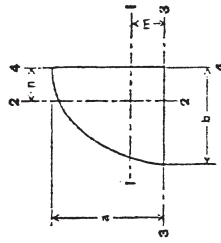

$$A = \frac{1}{4} \pi ab$$

$$m = \frac{4a}{3\pi}$$

$$n = \frac{4b}{3\pi}$$

$$I_1 = a^3 b \left(\frac{\pi}{16} - \frac{4}{9\pi} \right)$$

$$I_2 = ab^3 \left(\frac{\pi}{16} - \frac{4}{9\pi} \right)$$

$$I_3 = \frac{1}{16} \pi ab^3$$

$$I_4 = \frac{1}{16} \pi ab^3$$

ELLIPTIC COMPLEMENT

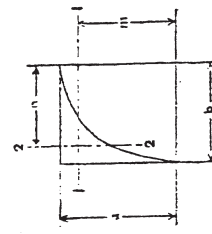

$$A = ab \left(1 - \frac{\pi}{4} \right)$$

$$m = \frac{a}{6 \left(1 - \frac{\pi}{4} \right)}$$

$$n = \frac{b}{6 \left(1 - \frac{\pi}{4} \right)}$$

$$I_1 = a^2 b \left(\frac{1}{3} - \frac{\pi}{16} - \frac{1}{36 \left(1 - \frac{\pi}{4} \right)} \right)$$

$$I_2 = ab^2 \left(\frac{1}{3} - \frac{\pi}{16} - \frac{1}{36 \left(1 - \frac{\pi}{4} \right)} \right)$$

PROPERTIES OF SECTIONS

REGULAR POLYGON

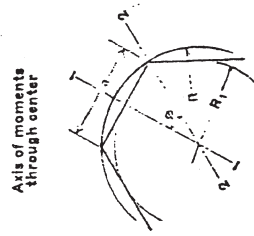

n = Number of sides

$$\phi = \frac{180^\circ}{n}$$

$$a = 2\sqrt{R^2 - R_1^2}$$

$$R = \frac{a}{2 \sin \phi}$$

$$R_1 = \frac{a}{2 \tan \phi}$$

$$A = \frac{1}{4} n a^2 \cot \phi = \frac{1}{2} n R^2 \sin 2\phi = n R_1^2 \tan \phi$$

$$I_1 = I_2 = \frac{A(8R^2 - a^2)}{24} = \frac{A(12R_1^2 + a^2)}{48}$$

$$I_3 = I_4 = \sqrt{\frac{6R^2 - a^2}{24}} = \sqrt{\frac{12R_1^2 + a^2}{48}}$$

ANGLE

Axis of moments through center of gravity

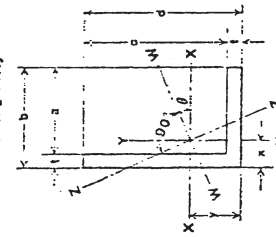

$$\tan 2\theta = \frac{2K}{I_y - I_x}$$

$$A = t(b+c) \quad x = \frac{b^2+ct}{2(b+c)} \quad y = \frac{d^2+at}{2(b+c)}$$

K = Product of Inertia about X, X' & Y, Y'

$$= \frac{abcdt}{4(b+c)}$$

$$I_x = \frac{1}{3} \left(t(d-y)^2 + by^2 + a(y-t)^2 \right)$$

$$I_y = \frac{1}{3} \left(t(b-x)^2 + dx^2 - c(x-t)^2 \right)$$

$$I_z = I_x \sin^2 \theta + I_y \cos^2 \theta + K \sin 2\theta$$

$$I_w = I_x \cos^2 \theta + I_y \sin^2 \theta - K \sin 2\theta$$

K is negative when heel of angle, with respect to the Y-axis, is in 2nd or 4th quadrant, positive when in 1st or 3rd quadrant.

Z-Z is axis of minimum I

BEAMS AND CHANNELS

Transverse force oblique through center of gravity

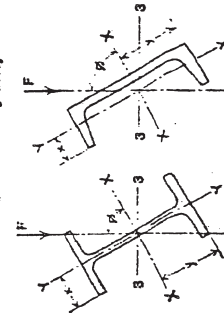

$$I_3 = I_x \sin^2 \phi + I_y \cos^2 \phi$$

$$I_4 = I_x \cos^2 \phi + I_y \sin^2 \phi$$

$$= M \left(\frac{1}{I_x} \sin \phi + \frac{1}{I_y} \cos \phi \right)$$

where M is bending moment due to force F. Extreming fiber assumed same as for case phi=0. If not, locate extreme fiber and find I by usual method.

D-25 Wind Chill Equivalent Temperatures on Exposed Flesh at Varying Velocity

| | | WIND VELOCITY (MILES PER HOUR) | | | | | | | | | |
|----------------|-----|--------------------------------|------|------|-----------|-----------|-----------|-----------|-----------|-----------|-----------|
| | | 45 | 35 | 25 | 20 | 15 | 10 | 5 | 3 | 2 | 1 |
| Temperature, F | 90 | 89.5 | 89 | 88.5 | 88 | 88.75 | 87.5 | 87 | 86 | 84.5 | 83 |
| | 82 | 81 | 80.5 | 80 | 79.5 | 78 | 76 | 74 | 72.5 | 70 | 60 |
| | 72 | 71 | 69.5 | 68 | 67 | 65 | 60 | 57 | 53.5 | 47.5 | 23 |
| | 63 | 61 | 59 | 57 | 55 | 52 | 44.5 | 39 | 34.5 | 20 | -11 |
| | 51 | 49 | 47 | 45 | 42.5 | 38 | 28 | 18.5 | 11 | 0 | -27 |
| | 41 | 39 | 36 | 34 | 30.5 | 25 | 11 | 0 | -9 | -23.5 | -38 |
| | 30 | 28 | 25 | 23 | 18 | 11 | -5 | -16.5 | -40 | Below -40 | Below -40 |
| | 20 | 18 | 14 | 11 | 6 | -2 | -19 | -40 | Below -40 | do | do |
| | 10 | 7.5 | 3 | 0 | -6 | -15 | -35 | Below -40 | do | do | do |
| | 0 | -2.5 | -8 | -12 | -18 | -29 | Below -40 | do | do | do | do |
| | -11 | -14 | -18 | -23 | -30 | Below -40 | do | do | do | do | do |
| | -21 | -24 | -30 | -35 | Below -40 | do | do | do | do | do | do |
| | -32 | -35 | -40 | -40 | | | | do | do | do | do |

Instructions for use of the table:

- (1) First obtain the temperature and wind velocity forecast data.
- (2) Locate the number at the top corresponding to the expected wind speed (or the number closest to this).
- (3) Read down this column until the number corresponding to the expected temperature (or the number closest to this) is reached.
- (4) From this point follow across to the right on the same line until the last number is reached under the column marked zero (0) wind speed.
- (5) This is the equivalent temperature reading. Example: weather information gives the expected temperature (at a given time, such as midnight) to be 35°F, and the expected wind speed (at the same time, midnight) to be 20 miles per hour (mph). Locate the 20 mph column at the top, follow down this column to the number nearest to 35°F. The nearest number is 34°F. From this point, move all the way to the right on the same line and find the last number, which is -38°F. This means that with a temperature of 35°F, and a windspeed of 20 mph the rate of cooling of all exposed flesh is the same as -38°F, with no wind.

do means ditto.

Reproduced by permission of the Department of the Army.

D-26 Impurities in Water

U. S. Systems of Expressing Impurities

- 1 grain per gallon = 1 grain calcium carbonate (CaCO₃) per U. S. gallon of water
- 1 part per million = 1 part calcium carbonate (CaCO₃) per 1,000,000 parts of water
- 1 part per hundred thousand .. = 1 part calcium carbonate (CaCO₃) per 100,000 parts of water

Foreign Systems of Expressing Impurities

- 1 English degree (or °Clark) .. = 1 grain calcium carbonate (CaCO₃) per British Imperial gal. of water
- 1 French degree = 1 part calcium carbonate (CaCO₃) per 100,000 parts of water
- 1 German degree = 1 part calcium oxide (CaO) per 100,000 parts of water

Conversions

| CONVERSION TABLE (Expressed to 3 Significant Figures) | Parts CaCO ₃ per Million (ppm) | Parts CaCO ₃ per Hundred Thousand (Pta./100,000) | Grains CaCO ₃ per U.S. Gallon (gr/gal) | English Degrees or ° Clark | French Degrees — ° French | German Degrees — ° German | Milli-equivalents per Liter or Equivalent per Million |
|--|---|--|---|-------------------------------------|------------------------------------|------------------------------------|--|
| 1 Part per Million | 1. | .1 | .0543 | .07 | .1 | .0560 | .020 |
| 1 Part per Hundred Thousand | 10.0 | 1. | .583 | .7 | 1. | .560 | .20 |
| 1 Grain per U. S. Gallon | 17.1 | 1.71 | 1. | 1.2 | 1.71 | .958 | .343 |
| 1 English or Clark Degree | 14.3 | 1.43 | .833 | 1. | 1.43 | .800 | .286 |
| 1 French Degree | 10. | 1. | .583 | .7 | 1. | .560 | .20 |
| 1 German Degree | 17.9 | 1.79 | 1.04 | 1.24 | 1.79 | 1. | .357 |
| 1 Milli-equivalent per Liter | | | | | | | |
| 1 Equivalent per Million | 50. | 5. | 2.92 | 3.50 | | 2.80 | 1. |

By permission, The Permutit Co., Inc., Data Book, 1953.

D-27 Water Analysis Conversions for Units Employed : Equivalents

| WATER ANALYSIS UNITS CONVERSION TABLE (Expressed to 3 Significant Figures) | Parts per Million (ppm) | Milligrams per Liter (mgm/L) | Grams per Liter (grms/L) | Parts per Hundred Thousand (Pta./100,000) | Grains U.S. Gallon (grs/U.S. gal) | Grains per British Imp. Gallon | Kilograms per Cubic Foot (Kgr/cu. ft.) |
|--|-------------------------------|------------------------------------|--------------------------------|--|---|--------------------------------------|--|
|--|-------------------------------|------------------------------------|--------------------------------|--|---|--------------------------------------|--|

| | | | | | | | |
|---------------------------------|-------|-------|-------|-------|-------|------|--------|
| 1 Part per Million | 1. | 1. | .001 | .1 | .0583 | .07 | .0004 |
| 1 Milligram per Liter | 1. | 1. | .001 | .1 | .0583 | .07 | .0004 |
| 1 Gram per Liter | 1000. | 1000. | 1. | 100. | 58.3 | 70. | .436 |
| 1 Part per Hundred Thousand | 10. | 10. | .01 | 1. | .583 | .7 | .00436 |
| 1 Grain per U.S. Gallon | 17.1 | 17.1 | .017 | 1.71 | 1. | 1.2 | .0075 |
| 1 Grain per British Imp. Gallon | 14.3 | 14.3 | .014 | 1.43 | .833 | 1. | .0062 |
| 1 Kilogram per Cubic Foot | 2294. | 2294. | 2.294 | 229.4 | 134. | 161. | 1. |

NOTE: In practice, water analysis samples are measured by volume, not by weight and corrections for variations in specific gravity are practically never made. Therefore, parts per million are assumed to be the same as milligrams per liter and hence the above relationships are, for practical purposes, true.

By permission, The Permutit Co., Inc., Data Book, 1953.

D-28 Parts Per Million to Grains Per U.S. Gallon

A. To convert parts per million of hardness to grains per U. S. gallon, divide by the factor 17.1.

B. To convert grains per U. S. gallons to parts per million of hardness, multiply by the factor 17.1.

Example:

$$1. \frac{242 \text{ parts/million}}{17.1} = 14.1 \text{ grains/U. S. gallon}$$

$$2. 24.3 \text{ grains/U. S. gallon} \times 17.1 = 416 \text{ parts/million}$$

Equivalents

Water analyses may also be expressed as:

- (1) Equivalents per million (epm) = $\frac{\text{No. of ppm of substance present}}{\text{Equivalent weight of substance}}$
- (2) Milli equivalents per liter (meq/l) = Equivalents per million
- (3) Parts per million expressed as CaCO₃ = $\frac{\text{No. of ppm CaCO}_3 \text{ equivalent to No. of ppm of substance present}}{\text{Equivalent weight of substance}}$
- (4) Fiftieths of equivalents per million (epm/50) = $\frac{\text{No. of ppm of substance present} \times 50}{\text{Equivalent weight of substance}}$

Notes: Numerically (1) and (2) are equal.
Numerically (3) and (4) are equal.

Section xxiii contains equivalent weights of a number of substances.
Section xxiii contains factors for converting various substances to CaCO₃.
Section xxiii contains factors for various chemical conversions.

By permission, The Permutit Co., Inc., Data Book, 1953.

D-29 Formulas, Molecular and Equivalent Weights, and Conversion Factors to CaCO₃ of Substances Frequently Appearing in the Chemistry of Water Softening

| Substance | Formula | Molecular weight | Equivalent weight | Multiplying Factor Considering molecular wt. of CaCO ₃ as 100. | |
|----------------------|--|------------------|-------------------|---|---|
| | | | | Substance to CaCO ₃ equivalent | CaCO ₃ equivalent to substance |
| Aluminum | Al | 27.0 | 9.0 | 5.56 | 0.18 |
| Aluminum Chloride | AlCl ₃ | 133. | 44.4 | 1.13 | 0.89 |
| Aluminum Chloride | AlCl ₃ ·6H ₂ O | 241. | 80.5 | 0.62 | 1.61 |
| Aluminum Sulfate | Al ₂ (SO ₄) ₃ ·(RH ₂ O) | 666.4 | 111.1 | 0.45 | 2.22 |
| Aluminum Sulfate | Al ₂ (SO ₄) ₃ (anhydrous) | 342.1 | 57.0 | 0.88 | 1.14 |
| Aluminum Hydroxide | Al(OH) ₃ | 78.0 | 26.0 | 1.52 | 0.52 |
| Alumina | Al ₂ O ₃ | 101.9 | 17.0 | 2.94 | 0.34 |
| Sodium Aluminate | Na ₂ Al ₂ O ₄ | 163.9 | 27.3 | 1.83 | 0.65 |
| Ammonium Alum | Al ₂ (SO ₄) ₃ ·(NH ₄) ₂ SO ₄ ·24H ₂ O | 906.6 | 151.1 | 0.33 | 3.02 |
| Potassium Alum | Al ₂ (SO ₄) ₃ ·K ₂ SO ₄ ·24H ₂ O | 948.8 | 156.1 | 0.32 | 3.12 |
| Ammonia | NH ₃ | 17.0 | 17.0 | 2.94 | 0.34 |
| Ammonium (Ion) | NH ₄ ⁺ | 18.0 | 18.0 | 2.78 | 0.36 |
| Ammonium Chloride | NH ₄ Cl | 53.5 | 53.5 | 0.94 | 1.07 |
| Ammonium Hydroxide | NH ₄ OH | 35.1 | 35.1 | 1.43 | 0.70 |
| Ammonium Sulfate | (NH ₄) ₂ SO ₄ | 132. | 66.1 | 0.76 | 1.32 |
| Barium | Ba | 137.4 | 68.7 | 0.73 | 1.37 |
| Barium Carbonate | BaCO ₃ | 197.4 | 98.7 | 0.51 | 1.97 |
| Barium Chloride | BaCl ₂ ·2H ₂ O | 244.3 | 122.2 | 0.41 | 2.44 |
| Barium Hydroxide | Ba(OH) ₂ | 171. | 85.7 | 0.59 | 1.71 |
| Barium Oxide | BaO | 153. | 76.7 | 0.65 | 1.53 |
| Barium Sulfate | BaSO ₄ | 233.4 | 116.7 | 0.43 | 2.33 |
| Calcium | Ca | 40.1 | 20.0 | 2.50 | 0.40 |
| Calcium Bicarbonate | Ca(HCO ₃) ₂ | 162.1 | 81.1 | 0.62 | 1.62 |
| Calcium Carbonate | CaCO ₃ | 100.08 | 50.1 | 1.00 | 1.00 |
| Calcium Chloride | CaCl ₂ | 111.0 | 55.5 | 0.90 | 1.11 |
| Calcium Hydrate | Ca(OH) ₂ | 74.1 | 37.1 | 1.35 | 0.74 |
| Calcium Hypochlorite | Ca(ClO) ₂ | 143.1 | 35.8 | 0.70 | 1.43 |
| Calcium Oxide | CaO | 56.1 | 28.0 | 1.79 | 0.56 |
| Calcium Sulfate | CaSO ₄ (anhydrous) | 136.1 | 68.1 | 0.74 | 1.36 |
| Calcium Sulfate | CaSO ₄ ·2H ₂ O (gypsum) | 172.2 | 86.1 | 0.68 | 1.72 |
| Calcium Nitrate | Ca(NO ₃) ₂ | 164.1 | 82.1 | 0.61 | 1.64 |
| Calcium Phosphate | Ca ₃ (PO ₄) ₂ | 310.3 | 61.7 | 0.97 | 1.03 |
| Carbon | C | 12.0 | 3.00 | 16.67 | 0.06 |

| | | | | | |
|-------------------------|---|-------|-------|-----------|-----------|
| Chlorine (Ion) | Cl | 35.5 | 35.5 | 1.41 | 0.71 |
| Copper (Cupric) | Cu | 63.6 | 31.8 | 1.57 | 0.64 |
| Copper Sulfate (Cupric) | CuSO ₄ | 160. | 80.0 | 0.63 | 1.60 |
| Copper Sulfate (Cupric) | CuSO ₄ ·5H ₂ O | 250. | 125. | 0.40 | 2.50 |
| Iron (Ferrous) | Fe ⁺⁺ | 55.8 | 27.9 | 1.79 | 0.56 |
| Iron (Ferric) | Fe ⁺⁺⁺ | 55.8 | 18.6 | 2.69 | 0.37 |
| Ferrous Carbonate | FeCO ₃ | 116. | 57.9 | 0.86 | 1.16 |
| Ferrous Hydroxide | Fe(OH) ₂ | 89.9 | 44.9 | 1.11 | 0.90 |
| Ferrous Oxide | FeO | 71.8 | 35.9 | 1.39 | 0.72 |
| Ferrous Sulfate | FeSO ₄ (anhydrous) | 151.9 | 76.0 | 0.66 | 1.62 |
| Ferrous Sulfate | FeSO ₄ ·7H ₂ O | 278.0 | 139.0 | 0.36 | 2.78 |
| Ferrous Sulfate | FeSO ₄ (anhydrous) | 151.9 | 151.9 | oxidation | oxidation |
| Ferric Chloride | FeCl ₃ | 162. | 54.1 | 0.93 | 1.08 |
| Ferric Chloride | FeCl ₃ ·6H ₂ O | 270. | 90.1 | 0.56 | 1.80 |
| Ferric Hydroxide | Fe(OH) ₃ | 107. | 35.8 | 1.41 | 0.71 |
| Ferric Oxide | Fe ₂ O ₃ | 160. | 26.6 | 1.88 | 0.53 |
| Ferric Sulfate (Ferric) | Fe ₂ (SO ₄) ₃ | 399.9 | 66.7 | 0.78 | 1.38 |
| Ferrous or Ferric | Fe or Fe | 55.8 | 55.8 | oxidation | oxidation |
| Ferrous Sulfate | FeSO ₄ | 151.9 | 151.9 | oxidation | oxidation |
| Fluorine | F | 19.0 | 19.0 | 2.66 | 0.38 |
| Hydrogen (Ion) | H | 1.01 | 1.01 | 50.0 | 0.02 |
| Iodine | I | 127. | 127. | 0.40 | 2.54 |
| Lead | Pb | 207. | 104. | 0.48 | 2.08 |
| Magnesium | Mg | 24.3 | 12.2 | 4.10 | 0.24 |
| Magnesium Oxide | MgO | 40.3 | 20.2 | 2.48 | 0.40 |
| Magnesium Bicarbonate | Mg(HCO ₃) ₂ | 146.3 | 73.2 | 0.68 | 1.46 |
| Magnesium Carbonate | MgCO ₃ | 84.3 | 42.2 | 1.19 | 0.84 |
| Magnesium Chloride | MgCl ₂ | 95.2 | 47.6 | 1.06 | 0.95 |
| Magnesium Hydrate | Mg(OH) ₂ | 58.3 | 29.2 | 1.71 | 0.58 |
| Magnesium Nitrate | Mg(NO ₃) ₂ | 148.3 | 74.2 | 0.67 | 1.48 |
| Magnesium Phosphate | Mg ₃ (PO ₄) ₂ | 262.9 | 43.8 | 1.14 | 0.88 |
| Magnesium Sulfate | MgSO ₄ | 120.4 | 60.2 | 0.83 | 1.20 |
| Manganese (Manganous) | Mn ⁺⁺ | 54.9 | 27.5 | 1.82 | 0.55 |
| Manganese (Manganic) | Mn ⁺⁺⁺ | 54.9 | 18.3 | 2.73 | 0.37 |
| Manganese Chloride | MnCl ₂ | 125.8 | 62.9 | 0.80 | 1.26 |
| Manganese Dioxide | MnO ₂ | 86.9 | 21.7 | 2.30 | 0.43 |
| Manganese Hydroxide | Mn(OH) ₂ | 89.0 | 44.4 | 1.13 | 0.89 |
| Manganic Oxide | Mn ₂ O ₃ | 158. | 26.3 | 1.90 | 0.53 |
| Manganous Oxide | MnO | 70.9 | 35.5 | 1.41 | 0.71 |

By permission, The Permutit Co., Inc., Data Book, 1953.

(continued on next page)

D-29
(Continued). Formulas, Molecular and Equivalent Weights, and
Conversion Factors to CaCO₃ of Substances Frequently
Appearing in the Chemistry of Water Softening

| Substance | Formula | Molecular weight | Equivalent weight | Multiplying Factor Considering molecular wt. of CaCO ₃ as 100. | |
|------------------------------|--|------------------|-------------------|---|--|
| | | | | Substance to CaCO ₃ equivalent | CaCO ₃ equivalent to substance |
| Nitrate (ion) | NO ₃ | 62.0 | 62.0 | 0.81 | 1.24 |
| Nitric Acid | HNO ₃ | 63.0 | 63.0 | 0.79 | 1.26 |
| Nitrogen (Valence 3) | N ⁺⁺⁺ | 14.0 | 4.67 | 10.8 | 0.093 |
| Nitrogen (Valence 5) | N ⁺⁺⁺⁺ | 14.0 | 2.80 | 17.9 | 0.056 |
| Oxygen | O | 16.0 | 8.00 | 6.25 | 0.16 |
| Phosphorus (Valence 3) | P ⁺⁺⁺ | 31.0 | 10.3 | 4.76 | 0.21 |
| Phosphorus (Valence 5) | P ⁺⁺⁺⁺ | 31.0 | 6.20 | 8.33 | 0.12 |
| Potassium | K | 39.1 | 39.1 | 1.28 | 0.78 |
| Potassium Carbonate | K ₂ CO ₃ | 138. | 69.1 | 0.72 | 1.38 |
| Potassium Chloride | KCl | 74.6 | 74.6 | 0.67 | 1.49 |
| Potassium Hydroxide | KOH | 56.1 | 56.1 | 0.88 | 1.12 |
| Silver Chloride | AgCl | 143.3 | 143.3 | 0.35 | 2.87 |
| Silver Nitrate | AgNO ₃ | 169.9 | 169.9 | 0.29 | 3.40 |
| Silica | SiO ₂ | 60.1 | 30.0 | 1.67 | 0.60 |
| Silicon | Si | 28.1 | 7.03 | 7.14 | 0.14 |
| Sodium | Na | 23.0 | 23.0 | 2.18 | 0.46 |
| Sodium Bicarbonate | NaHCO ₃ | 84.0 | 84.0 | 0.60 | 1.68 |
| Sodium Bisulfate | NaHSO ₄ | 120. | 120. | 0.83 | 1.20 |
| Sodium Bisulfite | NaHSO ₃ | 104. | 104. | 0.87 | 1.15 |
| Sodium Carbonate | Na ₂ CO ₃ | 106. | 53.0 | 0.94 | 1.06 |
| Sodium Carbonate | Na ₂ CO ₃ · 10H ₂ O | 286. | 143. | 0.35 | 2.86 |
| Sodium Chloride | NaCl | 58.5 | 58.5 | 0.85 | 1.17 |
| Sodium Hypochlorite | NaClO | 74.5 | 37.3 | 0.67 | 1.49 |
| Sodium Hydrate | NaOH | 40.0 | 40.0 | 1.25 | 0.80 |
| Sodium Nitrate | NaNO ₃ | 85.0 | 85.0 | 0.59 | 1.70 |
| Sodium Nitrite | NaNO ₂ | 69.0 | 34.5 | 0.73 | 1.38 |
| Sodium Oxide | Na ₂ O | 62.0 | 31.0 | 1.61 | 0.62 |
| Tri-sodium Phosphate | Na ₃ PO ₄ · 12H ₂ O (18.7% P ₂ O ₅) | 380.2 | 126.7 | 0.40 | 2.53 |
| Tri-sodium Phos. (anhydrous) | Na ₃ PO ₄ (43.2% P ₂ O ₅) | 164.0 | 54.7 | 0.91 | 1.09 |
| Di-sodium Phosphate | Na ₂ HPO ₄ · 12H ₂ O (19.8% P ₂ O ₅) | 358.2 | 119.4 | 0.42 | 2.39 |
| Di-sodium Phos. (anhydrous) | Na ₂ HPO ₄ (50% P ₂ O ₅) | 142.0 | 47.3 | 1.06 | 0.95 |
| Mono-sodium Phosphate | NaH ₂ PO ₄ · H ₂ O (51.4% P ₂ O ₅) | 138.1 | 46.0 | 1.09 | 0.92 |
| Mono-sod. phos. (anhydrous) | NaH ₂ PO ₄ (59.1% P ₂ O ₅) | 120.0 | 40.0 | 1.25 | 0.80 |
| Meta-Phosphate (Heagan) | NaPO ₃ (69% P ₂ O ₅) | 102.0 | 34.0 | 1.47 | 0.68 |
| Sodium Sulfate | Na ₂ SO ₄ · 10H ₂ O | 322.1 | 161.1 | 0.31 | 3.22 |
| Sodium Sulfate | Na ₂ SO ₄ | 142.1 | 71.0 | 0.70 | 1.42 |
| Sodium Thiosulfate | Na ₂ S ₂ O ₃ | 158.1 | 158.1 | 0.63 | 1.59 |
| Sodium Tetrathionate | Na ₂ S ₄ O ₆ | 270.2 | 135.1 | 0.37 | 2.71 |
| Sodium Sulfite | Na ₂ SO ₃ | 126.1 | 63.0 | 0.79 | 1.27 |
| Sulfur (Valence 2) | S ⁺⁺ | 32.1 | 16.0 | 3.13 | 0.32 |
| Sulfur (Valence 4) | S ⁺⁺⁺⁺ | 32.1 | 8.02 | 6.25 | 0.16 |
| Sulfur (Valence 6) | S ⁺⁺⁺⁺⁺ | 32.1 | 5.34 | 9.10 | 0.11 |
| Sulfur Dioxide | SO ₂ | 64.1 | 32.0 | 1.56 | 0.64 |
| Tin | Sn | 119. | 119. | 0.83 | 1.20 |
| Water | H ₂ O | 18.0 | 9.00 | 5.56 | 0.18 |
| Zinc | Zn | 65.4 | 32.7 | 1.54 | 0.65 |
| ACID RADICALS | | | | | |
| Bicarbonate | HCO ₃ | 61.0 | 61.0 | 0.82 | 1.22 |
| Carbonate | CO ₃ | 60.0 | 30.0 | 1.67 | 0.60 |
| Carbon Dioxide | CO ₂ | 44.0 | 22.0 | 2.27 | 0.44 |
| Chloride | Cl | 35.5 | 35.5 | 1.41 | 0.71 |
| Iodide | I | 126.9 | 126.9 | 0.40 | 2.54 |
| Nitrate | NO ₃ | 62.0 | 62.0 | 0.81 | 1.24 |
| Hydrate | OH | 17.0 | 17.0 | 2.94 | 0.34 |
| Phosphate | PO ₄ | 95.0 | 31.7 | 1.58 | 0.63 |
| Phosphorous Oxide | P ₂ O ₅ | 142.0 | 23.7 | 2.11 | 0.47 |
| Sulfide | S | 32.1 | 16.0 | 3.11 | 0.32 |
| Sulfate | SO ₄ | 96.1 | 48.0 | 1.04 | 0.96 |
| Sulfur Trioxide | SO ₃ | 80.1 | 40.0 | 1.25 | 0.80 |
| ACIDS | | | | | |
| Hydrogen | H | 1.0 | 1.0 | 50.00 | 0.02 |
| Acetic Acid | HC ₂ H ₃ O ₂ | 60.1 | 60.1 | 0.83 | 1.20 |
| Carbonic Acid | H ₂ CO ₃ | 62.0 | 31.0 | 1.61 | 0.62 |
| Hydrochloric Acid | HCl | 36.5 | 36.5 | 1.37 | 0.73 |
| Phosphoric Acid | H ₃ PO ₄ | 98.0 | 32.7 | 1.53 | 0.65 |
| Sulfurous Acid | H ₂ SO ₃ | 82.1 | 41.1 | 1.22 | 0.82 |
| Sulfuric Acid | H ₂ SO ₄ | 98.1 | 49.0 | 1.02 | 0.98 |
| Hydrogen Sulfide | H ₂ S | — | — | — | — |
| Manganous Acid | H ₂ MnO ₃ | 104.9 | 52.5 | 0.95 | 1.05 |

930 APPENDIX D

D-30

Grains Per U.S. Gallons – Pounds Per 1000 Gallons

- A.* To convert grains per U. S. gallons to pounds per 1000 gallons multiply by the factor 0.143.
- B.* To convert pounds per 1000 gallons to grains per U. S. gallons multiply by the factor 7.0.

Example:

1. 4.5 grains/U. S. gallon \times 0.143 = 0.644 lbs./1000 gals.
2. 0.5 lbs./1000 gallons \times 7.0 = 3.5 grains/U. S. gal.

D-31

Parts Per Million – Pounds Per 1000 Gallons

- A.* To convert parts per million to pounds per 1000 gallons divide by the factor 120.
- B.* To convert pounds per 1000 gallons to parts per million multiply by the factor 120.

Example:

1. 39 parts/million \div 120 = 0.325 lbs./1000 gals.
2. 0.167 lbs./1000 gals. \times 120 = 20 parts/million

D-32

Coagulant, Acid, and Sulfate—1 ppm Equivalents

| 1 Ppm Name of Chemical | 1 Ppm. Formula of Chemical | ppm Alkalinity Reduction | ppm SO ₂ as CaCO ₃ Increase | ppm Na ₂ SO ₄ Increase | ppm CO ₂ Increase | ppm Total Solids Increase |
|--|--|--------------------------------|---|--|------------------------------------|---------------------------------|
| Filter Alum | Al ₂ (SO ₄) ₃ · 18H ₂ O | 0.45 | 0.45 | 0.64 | 0.40 | 0.16 |
| Ammonia Alum | Al ₂ (SO ₄) ₃ · (NH ₄) ₂ SO ₄ · 24H ₂ O | 0.33 | 0.44 | 0.63 | 0.29 | 0.27 |
| Potash Alum | Al ₂ (SO ₄) ₃ · K ₂ SO ₄ · 24H ₂ O | 0.32 | 0.43 | 0.60 | 0.28 | 0.30 |
| Copperas (ferrous sulfate) | FeSO ₄ · 7H ₂ O | 0.36 | 0.36 | 0.61 | 0.31 | 0.13 |
| Chlorinated Copperas | FeSO ₄ · 7H ₂ O + (½Cl ₂) | 0.54 | 0.36 | 0.61 | 0.48 | 0.18 |
| Ferric Sulfate (100% Fe ₂ (SO ₄) ₃) | Fe ₂ (SO ₄) ₃ | 0.75 | 0.75 | 1.07 | 0.66 | 0.27 |
| Sulfuric Acid—98% | H ₂ SO ₄ | 1.00 | 1.00 | 1.42 | 0.88 | 0.38 |
| Sulfuric Acid—93.2% (66° Be) | H ₂ SO ₄ | 0.95 | 0.95 | 1.35 | 0.84 | 0.34 |
| Sulfuric Acid—77.7% (60° Be) | H ₂ SO ₄ | 0.79 | 0.79 | 1.13 | 0.70 | 0.28 |
| Salt Cake—95% | Na ₂ SO ₄ | — | 0.66 | 0.95 | — | 1.00 |

By permission, The Permutit Co., Inc., Data Book, 1953.

D-33 Alkali and Lime – 1 ppm Equivalents

| Name 1 Ppm | Formula 1 Ppm | Alkalinity A Increase ppm | Free CO ₂ Reduction ppm | T.H. as CaCO ₃ Increase ppm |
|--|---------------------------------|---------------------------------|--|--|
| Sodium Bicarbonate | NaHCO ₃ | 0.60 | — | — |
| Soda Ash (56% Na ₂ O = 99.16% Na ₂ CO ₃) | Na ₂ CO ₃ | 0.94 | 0.41 | — |
| Caustic Soda (78% Na ₂ O = 98.88% NaOH) | NaOH | 1.23 | 1.08 | — |
| Chemical Lime (Quicklime—Usually 99% CaO) | CaO | 1.61 | 1.41 | 1.61 |
| Hydrated Lime (Usually 93% Ca(OH) ₂) | Ca(OH) ₂ | 1.26 | 1.11 | 1.26 |

By permission, The Permutit Co., Inc., Data Book, 1953.

D-34 Sulfuric, Hydrochloric Acid Equivalent

| Name | Formula | Specific Gravity 60°/60°F. | Concentration | Grams/Liter | CaCO ₃ Equivalent to one lb. Acid | | |
|-------------------|---------|----------------------------------|---------------|-------------|---|--------|------|
| | | | | | Lbs. | Grains | |
| Sulfuric Acid | 60° Be | H ₂ SO ₄ | 1.7059 | 77.67% | 1325 | .7926 | 5548 |
| Sulfuric Acid | 66° Be | H ₂ SO ₄ | 1.8354 | 93.19% | 1710 | .9509 | 6657 |
| Sulfuric Acid | 98% | H ₂ SO ₄ | 1.8407 | 98.00% | 1804 | 1.0000 | 7000 |
| Hydrochloric Acid | 18° Be | HCl | 1.1417 | 27.92% | 319 | .3831 | 2682 |

By permission, The Permutit Co., Inc., Data Book, 1953.

D-35

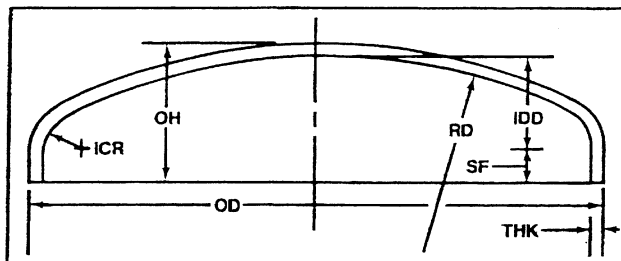

ASME FLANGED AND DISHED HEADS
IDD CHART

- OD - Outside Diameter
- THK - Thickness
- OH - Overall Height
- SF - Straight Flange
- RD - Radius of Dish
- ICR - Inside Corner Radius
- IDD - Inside Depth of Dish

For "Overall Height" add length of straight flange to IDD given, plus thickness of material.

Use when **RD EQUALS DIAMETER**

| OD | THK | ICR | 3/16" | 1/4" | 5/16" | 3/8" | 7/16" | 1/2" | 9/16" | 5/8" | 3/4" | 7/8" | 1 1/8" | 1 1/4" | 1 1/2" | 1 3/4" | 1 7/8" | 2" |
|-----|-------|-------|-------|-------|-------|-------|-------|-------|-------|-------|-------|-------|--------|--------|--------|--------|--------|----|
| 12 | 3/4 | 1.95 | 1.92 | 2.00 | 2.09 | | | | | | | | | | | | | |
| 14 | 1/4 | 2.29 | 2.26 | 2.27 | 2.35 | | | | | | | | | | | | | |
| 16 | 1 | 2.63 | 2.60 | 2.57 | 2.62 | | | | | | | | | | | | | |
| 18 | 1 1/4 | 2.97 | 2.94 | 2.91 | 2.98 | | | | | | | | | | | | | |
| 20 | 1 1/2 | 3.31 | 3.28 | 3.25 | 3.22 | | | | | | | | | | | | | |
| 22 | 1 1/4 | 3.73 | 3.75 | 3.67 | 3.64 | | | | | | | | | | | | | |
| 24 | 1 1/2 | 4.00 | 3.97 | 3.93 | 3.90 | | | | | | | | | | | | | |
| 26 | 2 1/4 | 4.72 | 4.69 | 4.66 | 4.63 | | | | | | | | | | | | | |
| 28 | 2 1/2 | 4.99 | 4.96 | 4.92 | 4.89 | | | | | | | | | | | | | |
| 30 | 2 3/4 | 5.25 | 5.22 | 5.19 | 5.16 | | | | | | | | | | | | | |
| 32 | 2 3/4 | 5.52 | 5.48 | 5.45 | 5.42 | | | | | | | | | | | | | |
| 34 | 2 3/4 | 5.78 | 5.75 | 5.72 | 5.69 | | | | | | | | | | | | | |
| 36 | 2 3/4 | 6.05 | 6.02 | 5.98 | 5.95 | | | | | | | | | | | | | |
| 38 | 3 | 6.78 | 6.74 | 6.71 | 6.68 | 6.65 | 6.62 | 6.59 | 6.56 | 6.53 | 6.50 | 6.44 | 6.38 | | | | | |
| 40 | 3 | 7.04 | 7.01 | 6.98 | 6.95 | 6.91 | 6.88 | 6.85 | 6.82 | 6.79 | 6.76 | 6.70 | 6.64 | | | | | |
| 42 | 3 | 7.31 | 7.27 | 7.24 | 7.21 | 7.18 | 7.15 | 7.12 | 7.08 | 7.05 | 7.02 | 6.96 | 6.90 | | | | | |
| 44 | 3 | 7.57 | 7.54 | 7.51 | 7.47 | 7.44 | 7.41 | 7.38 | 7.35 | 7.32 | 7.29 | 7.22 | 7.16 | | | | | |
| 46 | 3 | 7.84 | 7.80 | 7.77 | 7.74 | 7.71 | 7.68 | 7.64 | 7.61 | 7.58 | 7.55 | 7.49 | 7.43 | | | | | |
| 48 | 3 | 8.10 | 8.07 | 8.04 | 8.00 | 7.97 | 7.94 | 7.91 | 7.88 | 7.85 | 7.81 | 7.75 | 7.69 | | | | | |
| 50 | 3 | 8.37 | 8.34 | 8.30 | 8.27 | 8.24 | 8.21 | 8.17 | 8.14 | 8.11 | 8.08 | 8.02 | 7.95 | | | | | |
| 52 | 3 1/4 | 9.09 | 9.06 | 9.03 | 8.99 | 8.96 | 8.93 | 8.90 | 8.87 | 8.84 | 8.80 | 8.74 | 8.68 | | | | | |
| 54 | 3 1/4 | 9.35 | 9.32 | 9.29 | 9.26 | 9.23 | 9.19 | 9.16 | 9.13 | 9.10 | 9.07 | 9.01 | 8.94 | | | | | |
| 56 | 3 1/4 | 9.62 | 9.59 | 9.56 | 9.52 | 9.49 | 9.46 | 9.43 | 9.40 | 9.36 | 9.33 | 9.27 | 9.21 | | | | | |
| 58 | 3 1/4 | 9.89 | 9.85 | 9.82 | 9.79 | 9.76 | 9.72 | 9.69 | 9.66 | 9.63 | 9.60 | 9.53 | 9.47 | | | | | |
| 60 | 3 1/4 | 10.15 | 10.12 | 10.09 | 10.05 | 10.02 | 9.99 | 9.96 | 9.93 | 9.89 | 9.86 | 9.80 | 9.74 | | | | | |
| 62 | 3 1/4 | 10.42 | 10.39 | 10.35 | 10.32 | 10.29 | 10.26 | 10.22 | 10.19 | 10.16 | 10.13 | 10.06 | 10.00 | | | | | |
| 64 | 4 1/4 | 10.89 | 10.85 | 10.82 | 10.88 | 10.85 | 10.83 | 10.79 | 10.76 | 10.73 | 10.70 | 10.64 | 10.57 | | | | | |
| 66 | 4 1/4 | 11.25 | 11.22 | 11.19 | 11.16 | 11.12 | 11.09 | 11.06 | 11.03 | 10.99 | 10.96 | 10.90 | 10.84 | | | | | |
| 68 | 4 1/4 | 11.52 | 11.49 | 11.45 | 11.42 | 11.39 | 11.36 | 11.32 | 11.29 | 11.26 | 11.23 | 11.16 | 11.10 | | | | | |
| 70 | 4 1/4 | 11.78 | 11.75 | 11.72 | 11.69 | 11.65 | 11.62 | 11.59 | 11.56 | 11.53 | 11.49 | 11.43 | 11.37 | | | | | |
| 72 | 4 1/4 | 12.35 | 12.32 | 12.29 | 12.26 | 12.22 | 12.19 | 12.16 | 12.13 | 12.10 | 12.06 | 12.00 | 11.94 | | | | | |
| 74 | 4 1/4 | 12.62 | 12.59 | 12.55 | 12.52 | 12.49 | 12.46 | 12.43 | 12.39 | 12.36 | 12.33 | 12.27 | 12.20 | | | | | |
| 76 | 4 1/4 | 12.89 | 12.85 | 12.82 | 12.79 | 12.76 | 12.72 | 12.69 | 12.66 | 12.63 | 12.59 | 12.53 | 12.47 | | | | | |
| 78 | 4 1/4 | 13.15 | 13.12 | 13.09 | 13.05 | 13.02 | 12.99 | 12.96 | 12.92 | 12.89 | 12.86 | 12.80 | 12.73 | | | | | |
| 80 | 5 | 13.57 | 13.54 | 13.50 | 13.47 | 13.44 | 13.41 | 13.37 | 13.34 | 13.31 | 13.28 | 13.21 | 13.15 | | | | | |
| 82 | 5 | 13.84 | 13.80 | 13.77 | 13.74 | 13.70 | 13.67 | 13.64 | 13.61 | 13.57 | 13.54 | 13.48 | 13.41 | | | | | |
| 84 | 5 1/4 | 14.56 | 14.52 | 14.49 | 14.46 | 14.43 | 14.39 | 14.36 | 14.33 | 14.30 | 14.27 | 14.20 | 14.14 | | | | | |
| 86 | 5 1/4 | 14.82 | 14.79 | 14.76 | 14.72 | 14.69 | 14.66 | 14.63 | 14.60 | 14.56 | 14.53 | 14.47 | 14.40 | | | | | |
| 88 | 5 1/4 | 15.09 | 15.05 | 15.02 | 14.99 | 14.96 | 14.92 | 14.89 | 14.86 | 14.83 | 14.80 | 14.73 | 14.67 | | | | | |
| 90 | 5 1/4 | 15.35 | 15.32 | 15.29 | 15.26 | 15.22 | 15.19 | 15.16 | 15.13 | 15.09 | 15.06 | 15.00 | 14.93 | | | | | |
| 92 | 5 1/4 | 15.62 | 15.59 | 15.55 | 15.52 | 15.49 | 15.46 | 15.42 | 15.39 | 15.36 | 15.33 | 15.26 | 15.20 | | | | | |
| 94 | 5 1/4 | 15.89 | 15.85 | 15.82 | 15.79 | 15.75 | 15.72 | 15.69 | 15.66 | 15.62 | 15.59 | 15.53 | 15.46 | | | | | |
| 96 | 6 1/4 | 16.61 | 16.57 | 16.54 | 16.51 | 16.48 | 16.44 | 16.41 | 16.38 | 16.35 | 16.32 | 16.25 | 16.19 | | | | | |
| 98 | 6 1/4 | 16.87 | 16.84 | 16.81 | 16.77 | 16.74 | 16.71 | 16.68 | 16.64 | 16.61 | 16.58 | 16.52 | 16.45 | | | | | |
| 100 | 6 1/4 | 17.14 | 17.10 | 17.07 | 17.04 | 17.01 | 16.97 | 16.94 | 16.91 | 16.88 | 16.85 | 16.78 | 16.72 | | | | | |
| 102 | 6 1/4 | 17.40 | 17.37 | 17.34 | 17.31 | 17.27 | 17.24 | 17.21 | 17.18 | 17.14 | 17.11 | 17.05 | 16.98 | | | | | |
| 104 | 6 1/4 | 17.67 | 17.64 | 17.60 | 17.57 | 17.54 | 17.51 | 17.47 | 17.44 | 17.41 | 17.38 | 17.31 | 17.25 | | | | | |
| 106 | 6 1/4 | 17.94 | 17.90 | 17.87 | 17.84 | 17.80 | 17.77 | 17.74 | 17.71 | 17.67 | 17.64 | 17.58 | 17.51 | | | | | |
| 108 | 6 1/4 | 18.20 | 18.17 | 18.14 | 18.10 | 18.07 | 18.04 | 18.00 | 17.97 | 17.94 | 17.91 | 17.84 | 17.78 | | | | | |
| 110 | 7 1/4 | 18.92 | 18.89 | 18.86 | 18.82 | 18.79 | 18.76 | 18.73 | 18.69 | 18.66 | 18.63 | 18.57 | 18.50 | | | | | |
| 112 | 7 1/4 | 19.19 | 19.15 | 19.12 | 19.09 | 19.06 | 19.02 | 18.99 | 18.96 | 18.93 | 18.89 | 18.83 | 18.77 | | | | | |
| 114 | 7 1/4 | 19.45 | 19.42 | 19.39 | 19.36 | 19.32 | 19.29 | 19.26 | 19.23 | 19.19 | 19.16 | 19.10 | 19.03 | | | | | |
| 116 | 7 1/4 | 19.72 | 19.69 | 19.65 | 19.62 | 19.59 | 19.56 | 19.52 | 19.49 | 19.46 | 19.43 | 19.36 | 19.30 | | | | | |
| 118 | 7 1/4 | 19.99 | 19.95 | 19.92 | 19.89 | 19.85 | 19.82 | 19.79 | 19.76 | 19.72 | 19.69 | 19.63 | 19.56 | | | | | |
| 120 | 7 1/4 | 20.25 | 20.22 | 20.19 | 20.15 | 20.12 | 20.09 | 20.05 | 20.02 | 19.99 | 19.96 | 19.89 | 19.83 | | | | | |

On Application

By permission, Hackney-Brighton, a division of Trinity Industries.

D-35

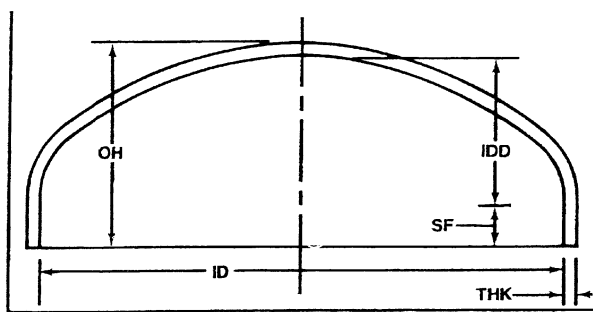

ELLIPTICAL HEADS (2:1 RATIO)

- ID - Inside Diameter
- THK - Thickness
- OH - Overall Height
- SF - Straight Flange
- IDD - Inside Depth of Dish
- X - STANDARD
- I - INQUIRE

SIZES AND THICKNESSES OF HEADS

| THK | 3/16 | 1/4 | 5/16 | 3/8 | 7/16 | 1/2 | 5/8 | 3/4 | 7/8 | 1 | 1 1/8 | 1 1/4 | 1 3/8 | 1 1/2 | 1 5/8 | 1 3/4 | 2 | 2 1/4 | 2 1/2 | 3 | 3 1/4 | 3 1/2 | 3 3/4 | 4 | 4 1/4 | 4 1/2 | 4 3/4 | 5 | 5 1/4 | 5 1/2 | 5 3/4 | 6 | 6 1/4 | 7 | 8 | THK | | |
|-----|------|-----|------|-----|------|-----|-----|-----|-----|---|-------|-------|-------|-------|-------|-------|---|-------|-------|---|-------|-------|-------|---|-------|-------|-------|---|-------|-------|-------|---|-------|---|---|-----|----|-----|
| ID | | | | | | | | | | | | | | | | | | | | | | | | | | | | | | | | | | | | | ID | |
| 6 | X | X | X | X | X | X | X | X | X | X | X | X | X | X | X | X | X | X | X | X | X | X | X | X | X | X | X | X | X | X | X | X | X | X | X | X | 6 | |
| 8 | X | X | X | X | X | X | X | X | X | X | X | X | X | X | X | X | X | X | X | X | X | X | X | X | X | X | X | X | X | X | X | X | X | X | X | X | X | 8 |
| 10 | X | X | X | X | X | X | X | X | X | X | X | X | X | X | X | X | X | X | X | X | X | X | X | X | X | X | X | X | X | X | X | X | X | X | X | X | X | 10 |
| 12 | X | X | X | X | X | X | X | X | X | X | X | X | X | X | X | X | X | X | X | X | X | X | X | X | X | X | X | X | X | X | X | X | X | X | X | X | X | 12 |
| 14 | X | X | X | X | X | X | X | X | X | X | X | X | X | X | X | X | X | X | X | X | X | X | X | X | X | X | X | X | X | X | X | X | X | X | X | X | X | 14 |
| 16 | X | X | X | X | X | X | X | X | X | X | X | X | X | X | X | X | X | X | X | X | X | X | X | X | X | X | X | X | X | X | X | X | X | X | X | X | X | 16 |
| 18 | X | X | X | X | X | X | X | X | X | X | X | X | X | X | X | X | X | X | X | X | X | X | X | X | X | X | X | X | X | X | X | X | X | X | X | X | X | 18 |
| 20 | X | X | X | X | X | X | X | X | X | X | X | X | X | X | X | X | X | X | X | X | X | X | X | X | X | X | X | X | X | X | X | X | X | X | X | X | X | 20 |
| 22 | X | X | X | X | X | X | X | X | X | X | X | X | X | X | X | X | X | X | X | X | X | X | X | X | X | X | X | X | X | X | X | X | X | X | X | X | X | 22 |
| 24 | X | X | X | X | X | X | X | X | X | X | X | X | X | X | X | X | X | X | X | X | X | X | X | X | X | X | X | X | X | X | X | X | X | X | X | X | X | 24 |
| 30 | X | X | X | X | X | X | X | X | X | X | X | X | X | X | X | X | X | X | X | X | X | X | X | X | X | X | X | X | X | X | X | X | X | X | X | X | X | 30 |
| 36 | X | X | X | X | X | X | X | X | X | X | X | X | X | X | X | X | X | X | X | X | X | X | X | X | X | X | X | X | X | X | X | X | X | X | X | X | X | 36 |
| 42 | X | X | X | X | X | X | X | X | X | X | X | X | X | X | X | X | X | X | X | X | X | X | X | X | X | X | X | X | X | X | X | X | X | X | X | X | X | 42 |
| 48 | X | X | X | X | X | X | X | X | X | X | X | X | X | X | X | X | X | X | X | X | X | X | X | X | X | X | X | X | X | X | X | X | X | X | X | X | X | 48 |
| 54 | X | X | X | X | X | X | X | X | X | X | X | X | X | X | X | X | X | X | X | X | X | X | X | X | X | X | X | X | X | X | X | X | X | X | X | X | X | 54 |
| 60 | X | X | X | X | X | X | X | X | X | X | X | X | X | X | X | X | X | X | X | X | X | X | X | X | X | X | X | X | X | X | X | X | X | X | X | X | X | 60 |
| 66 | X | X | X | X | X | X | X | X | X | X | X | X | X | X | X | X | X | X | X | X | X | X | X | X | X | X | X | X | X | X | X | X | X | X | X | X | X | 66 |
| 72 | X | X | X | X | X | X | X | X | X | X | X | X | X | X | X | X | X | X | X | X | X | X | X | X | X | X | X | X | X | X | X | X | X | X | X | X | X | 72 |
| 78 | X | X | X | X | X | X | X | X | X | X | X | X | X | X | X | X | X | X | X | X | X | X | X | X | X | X | X | X | X | X | X | X | X | X | X | X | X | 78 |
| 84 | X | X | X | X | X | X | X | X | X | X | X | X | X | X | X | X | X | X | X | X | X | X | X | X | X | X | X | X | X | X | X | X | X | X | X | X | X | 84 |
| 90 | X | X | X | X | X | X | X | X | X | X | X | X | X | X | X | X | X | X | X | X | X | X | X | X | X | X | X | X | X | X | X | X | X | X | X | X | X | 90 |
| 96 | X | X | X | X | X | X | X | X | X | X | X | X | X | X | X | X | X | X | X | X | X | X | X | X | X | X | X | X | X | X | X | X | X | X | X | X | X | 96 |
| 102 | X | X | X | X | X | X | X | X | X | X | X | X | X | X | X | X | X | X | X | X | X | X | X | X | X | X | X | X | X | X | X | X | X | X | X | X | X | 102 |
| 108 | X | X | X | X | X | X | X | X | X | X | X | X | X | X | X | X | X | X | X | X | X | X | X | X | X | X | X | X | X | X | X | X | X | X | X | X | X | 108 |
| 114 | X | X | X | X | X | X | X | X | X | X | X | X | X | X | X | X | X | X | X | X | X | X | X | X | X | X | X | X | X | X | X | X | X | X | X | X | X | 114 |
| 120 | X | X | X | X | X | X | X | X | X | X | X | X | X | X | X | X | X | X | X | X | X | X | X | X | X | X | X | X | X | X | X | X | X | X | X | X | X | 120 |

Elliptical
(2:1 Ratio)

By permission, Hackney-Brighton, a division of Trinity Industries.

D-35

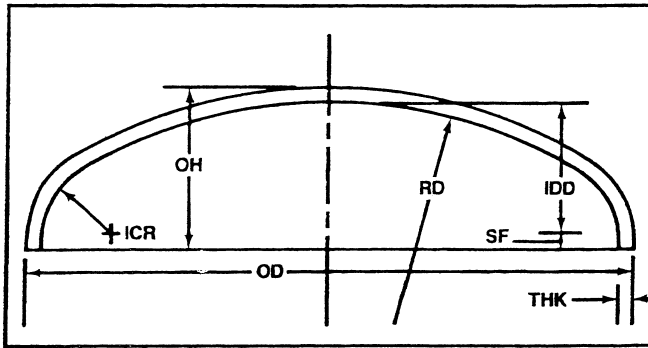

80-10® HEADS

- OD — Outside Diameter
- THK — Thickness
- OH — Overall Height
- SF — Straight Flange
- RD — Radius of Dish
- ICR — Inside Corner Radius
- IDD — Inside Depth of Dish

Meeting all A.S.M.E. Unfired Pressure Vessel Code requirements, the 80-10* Head permits significantly higher pressures than other configurations selected for the same service. The 80-10* Head is named for its unique dimensions—the dish radius equals 80% of the head diameter and the inside corner radius equals 10% of the head diameter. These dimensions compare to 100% and 6% respectively for A.S.M.E. F&D Heads.

Figure 1.

INTERNAL PRESSURE COMPARISON

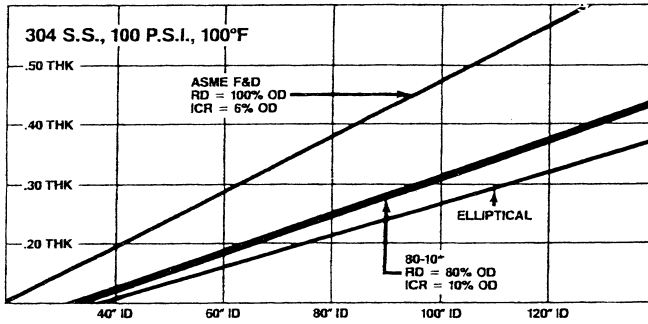
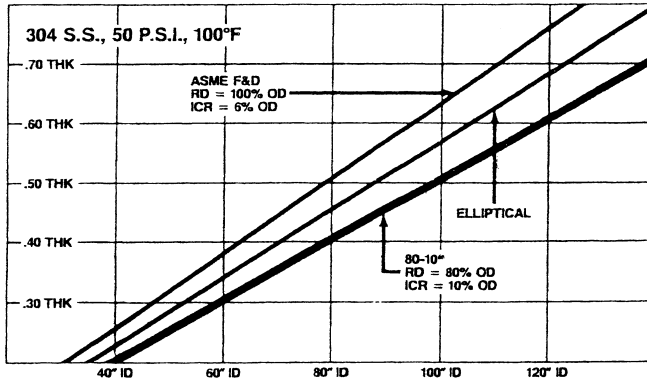

Figure 2.

EXTERNAL PRESSURE COMPARISON



By permission, Hackney-Brighton, Division of Trinity Industries.